

## 2.8W filter-free mono class D audio power amplifier

### Features

- Operating from  $V_{CC}=2.4V$  to 5.5V
- Standby mode active low
- Output power: 2.8W into 4Ω and 1.7W into 8Ω with 10% THD+N max and 5V power supply
- Output power: 2.2W @5V or 0.7W @ 3.0V into 4Ω with 1% THD+N max.
- Output power: 1.4W @5V or 0.5W @ 3.0V into 8Ω with 1% THD+N max.
- Adjustable gain via external resistors
- Low current consumption 2mA @ 3V
- Efficiency: 88% typ.
- Signal to noise ratio: 85dB typ.
- PSRR: 63dB typ. @217Hz with 6dB gain
- PWM base frequency: 280kHz
- Low pop & click noise
- Thermal shutdown protection
- Available in DFN8 3X3 mm package

### Description

The TS4962 is a differential class-D BTL power amplifier. It is able to drive up to 2.2W into a 4Ω load and 1.4W into a 8Ω load at 5V. It achieves outstanding efficiency (88% typ.) compared to standard AB-class audio amps.

The gain of the device can be controlled via two external gain-setting resistors. Pop & click reduction circuitry provides low on/off switch noise while allowing the device to start within 5ms. A standby function (active low) allows the reduction of current consumption to 10nA typ.

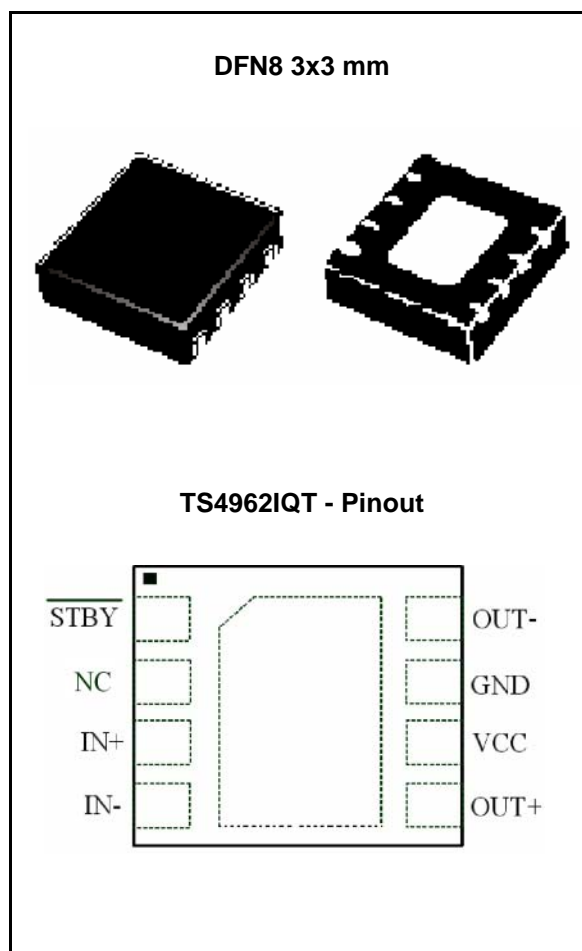

### Applications

- Cellular phone
- PDA
- Notebook PC

# Contents

<b>1</b>	<b>Absolute maximum ratings and operating conditions</b>	<b>6</b>
<b>2</b>	<b>Application component information</b>	<b>8</b>
<b>3</b>	<b>Electrical characteristics</b>	<b>9</b>
3.1	Electrical characteristics tables	9
3.2	Electrical characteristics curves	21
<b>4</b>	<b>Application information</b>	<b>32</b>
4.1	Differential configuration principle	32
4.2	Gain in typical application schematic	32
4.3	Common mode feedback loop limitations	33
4.4	Low frequency response	33
4.5	Decoupling of the circuit	34
4.6	Wake-up time ( $t_{WU}$ )	34
4.7	Shutdown time ( $t_{STBY}$ )	34
4.8	Consumption in standby mode	34
4.9	Single-ended input configuration	35
4.10	Output filter considerations	36
4.11	Several examples with summed inputs	37
	Example 1: Dual differential inputs.	37
	Example 2: One differential input plus one single ended input	38
<b>5</b>	<b>Demo board</b>	<b>39</b>
<b>6</b>	<b>Recommended footprint</b>	<b>41</b>
<b>7</b>	<b>DFN8 package information</b>	<b>42</b>
<b>8</b>	<b>Ordering information</b>	<b>44</b>
<b>9</b>	<b>Revision history</b>	<b>45</b>

## List of tables

Table 1.	Absolute maximum ratings .....	6
Table 2.	Dissipation ratings .....	6
Table 3.	Operating conditions .....	7
Table 4.	Component information .....	8
Table 5.	Electrical characteristics at $V_{CC} = +5V$ , with $GND = 0V$ , $V_{icm} = 2.5V$ , and $T_{amb} = 25^{\circ}C$ (unless otherwise specified) .....	9
Table 6.	Electrical characteristics at $V_{CC} = +4.2V$ with $GND = 0V$ , $V_{icm} = 2.1V$ , and $T_{amb} = 25^{\circ}C$ (unless otherwise specified) .....	11
Table 7.	Electrical characteristics at $V_{CC} = +3.6V$ with $GND = 0V$ , $V_{icm} = 1.8V$ , $T_{amb} = 25^{\circ}C$ (unless otherwise specified) .....	13
Table 8.	Electrical characteristics at $V_{CC} = +3.0V$ with $GND = 0V$ , $V_{icm} = 1.5V$ , $T_{amb} = 25^{\circ}C$ (unless otherwise specified) .....	15
Table 9.	Electrical characteristics at $V_{CC} = +2.5V$ with $GND = 0V$ , $V_{icm} = 1.25V$ , $T_{amb} = 25^{\circ}C$ (unless otherwise specified) .....	17
Table 10.	Electrical characteristics at $V_{CC} +2.4V$ with $GND = 0V$ , $V_{icm} = 1.2V$ , $T_{amb} = 25^{\circ}C$ (unless otherwise specified) .....	19
Table 11.	Order codes .....	44
Table 12.	Document revision history .....	45

## List of figures

Figure 1.	Typical application schematics . . . . .	8
Figure 2.	Schematic used for test measurements . . . . .	21
Figure 3.	Schematic used for PSSR measurements . . . . .	21
Figure 4.	Current consumption vs. power supply voltage . . . . .	22
Figure 6.	Current consumption vs. standby voltage . . . . .	22
Figure 7.	Output offset voltage vs. common mode input voltage . . . . .	22
Figure 8.	Efficiency vs. output power . . . . .	22
Figure 9.	Efficiency vs. output power . . . . .	22
Figure 10.	Efficiency vs. output power . . . . .	23
Figure 11.	Efficiency vs. output power . . . . .	23
Figure 12.	Output power vs. power supply voltage . . . . .	23
Figure 13.	Output power vs. power supply voltage . . . . .	23
Figure 14.	PSRR vs. frequency . . . . .	23
Figure 15.	PSRR vs. frequency . . . . .	23
Figure 16.	PSRR vs. frequency . . . . .	24
Figure 17.	PSRR vs. frequency . . . . .	24
Figure 18.	PSRR vs. frequency . . . . .	24
Figure 19.	PSRR vs. frequency . . . . .	24
Figure 20.	PSRR vs. common mode input voltage . . . . .	24
Figure 21.	CMRR vs. frequency . . . . .	24
Figure 22.	CMRR vs. frequency . . . . .	25
Figure 23.	CMRR vs. frequency . . . . .	25
Figure 24.	CMRR vs. frequency . . . . .	25
Figure 25.	CMRR vs. frequency . . . . .	25
Figure 26.	CMRR vs. frequency . . . . .	25
Figure 27.	CMRR vs. common mode input voltage . . . . .	25
Figure 28.	THD+N vs. output power . . . . .	26
Figure 29.	THD+N vs. output power . . . . .	26
Figure 30.	THD+N vs. output power . . . . .	26
Figure 31.	THD+N vs. output power . . . . .	26
Figure 32.	THD+N vs. output power . . . . .	26
Figure 33.	THD+N vs. output power . . . . .	26
Figure 34.	THD+N vs. output power . . . . .	27
Figure 35.	THD+N vs. output power . . . . .	27
Figure 36.	THD+N vs. frequency . . . . .	27
Figure 37.	THD+N vs. frequency . . . . .	27
Figure 38.	THD+N vs. frequency . . . . .	27
Figure 39.	THD+N vs. frequency . . . . .	27
Figure 40.	THD+N vs. frequency . . . . .	28
Figure 41.	THD+N vs. frequency . . . . .	28
Figure 42.	THD+N vs. frequency . . . . .	28
Figure 43.	THD+N vs. frequency . . . . .	28
Figure 44.	THD+N vs. frequency . . . . .	28
Figure 45.	THD+N vs. frequency . . . . .	28
Figure 46.	THD+N vs. frequency . . . . .	29
Figure 47.	THD+N vs. frequency . . . . .	29
Figure 48.	Gain vs. frequency . . . . .	29
Figure 49.	Gain vs. frequency . . . . .	29

Figure 50. Gain vs. frequency ..... 29

Figure 51. Gain vs. frequency ..... 29

Figure 52. Gain vs. frequency ..... 30

Figure 53. Gain vs. frequency ..... 30

Figure 54. Gain vs. frequency ..... 30

Figure 55. Startup & shutdown time  $V_{CC} = 5V$ ,  $G = 6dB$ ,  $C_{in} = 1\mu F$  (5ms/div) ..... 30

Figure 56. Startup & shutdown time  $V_{CC} = 3V$ ,  $G = 6dB$ ,  $C_{in} = 1\mu F$  (5ms/div) ..... 30

Figure 57. Startup & shutdown time  $V_{CC} = 5V$ ,  $G = 6dB$ ,  $C_{in} = 100nF$  (5ms/div) ..... 30

Figure 58. Startup & shutdown time  $V_{CC} = 3V$ ,  $G = 6dB$ ,  $C_{in} = 100nF$  (5ms/div) ..... 31

Figure 59. Startup & shutdown time  $V_{CC} = 5V$ ,  $G = 6dB$ , No  $C_{in}$  (5ms/div) ..... 31

Figure 60. Startup & shutdown time  $V_{CC} = 3V$ ,  $G = 6dB$ , No  $C_{in}$  (5ms/div) ..... 31

Figure 61. Single-ended input typical application ..... 35

Figure 62. Typical application schematic with multiple single-ended inputs ..... 35

Figure 63. Method for shorting perturbations to ground ..... 37

Figure 64. Typical application schematic with dual differential inputs ..... 37

Figure 65. Typical application schematic with one differential input plus one single-ended input . . . 38

Figure 66. Schematic diagram of mono class D demoboard for the TS4962 DFN package ..... 39

Figure 67. Top view ..... 39

Figure 68. Bottom layer ..... 40

Figure 69. Top layer ..... 40

Figure 70. Recommended footprint for TS4962 DFN package ..... 41

Figure 71. DFN8 3x3 exposed pad package ..... 43

# 1 Absolute maximum ratings and operating conditions

**Table 1. Absolute maximum ratings**

Symbol	Parameter	Value	Unit
$V_{CC}$	Supply voltage <sup>(1), (2)</sup>	6	V
$V_i$	Input voltage <sup>(3)</sup>	GND to $V_{CC}$	V
$T_{oper}$	Operating free air temperature range	-40 to + 85	°C
$T_{stg}$	Storage temperature	-65 to +150	°C
$T_j$	Maximum junction temperature	150	°C
$R_{thja}$	Thermal resistance junction to ambient DFN8 package	120	°C/W
$P_d$	Power dissipation	Internally limited <sup>(4)</sup>	
ESD	Human body model	2	kV
ESD	Machine model	200	V
Latch-up	Latch-up immunity	200	mA
$V_{STBY}$	Standby pin voltage maximum voltage <sup>(5)</sup>	GND to $V_{CC}$	V
	Lead temperature (soldering, 10sec)	260	°C

1. Caution: This device is not protected in the event of abnormal operating conditions such as, for example, short-circuiting between any one output pin and ground, between any one output pin and  $V_{CC}$ , and between individual output pins.
2. All voltage values are measured with respect to the ground pin.
3. The magnitude of the input signal must never exceed  $V_{CC} + 0.3V$  / GND - 0.3V.
4. Exceeding the power derating curves during a long period will provoke abnormal operation.
5. The magnitude of the standby signal must never exceed  $V_{CC} + 0.3V$  / GND - 0.3V.

**Table 2. Dissipation ratings**

Package	Derating factor	Power rating @25°C	Power rating @ 85°C
DFN8	20 mW / °C	2.5 W	1.3 W

**Table 3. Operating conditions**

Symbol	Parameter	Value	Unit
$V_{CC}$	Supply voltage <sup>(1)</sup>	2.4 to 5.5	V
$V_{IC}$	Common mode input voltage range <sup>(2)</sup>	0.5 to $V_{CC}-0.8$	V
$V_{STBY}$	Standby voltage input: <sup>(3)</sup> Device ON Device OFF	$1.4 \leq V_{STBY} \leq V_{CC}$ $GND \leq V_{STBY} \leq 0.4$ <sup>(4)</sup>	V
$R_L$	Load resistor	$\geq 4$	$\Omega$
$R_{thja}$	Thermal resistance junction to ambient DFN8 package <sup>(5)</sup>	50	$^{\circ}\text{C}/\text{W}$

1. For  $V_{CC}$  between 2.4V and 2.5V, the operating temperature range is reduced to  $0^{\circ}\text{C} \leq T_{amb} \leq 70^{\circ}\text{C}$ .
2. For  $V_{CC}$  between 2.4V and 2.5V, the common mode input range must be set at  $V_{CC}/2$ .
3. Without any signal on  $V_{STBY}$ , the device will be in standby.
4. Minimum current consumption is obtained when  $V_{STBY} = GND$ .
5. When mounted on a 4-layer PCB.

## 2 Application component information

Table 4. Component information

Component	Functional description
$C_S$	Bypass supply capacitor. Install as close as possible to the TS4962 to minimize high-frequency ripple. A 100nF ceramic capacitor should be added to enhance the power supply filtering at high frequency.
$R_{in}$	Input resistor used to program the TS4962 differential gain ( $Gain = 300k\Omega/R_{in}$ with $R_{in}$ in $k\Omega$ ).
Input capacitor	Because of common mode feedback these input capacitors are optional. However, they can be added to form with $R_{in}$ a 1st order high pass filter with $-3dB$ cut-off frequency $= 1/(2*\pi*R_{in}*C_{in})$ .

Figure 1. Typical application schematics

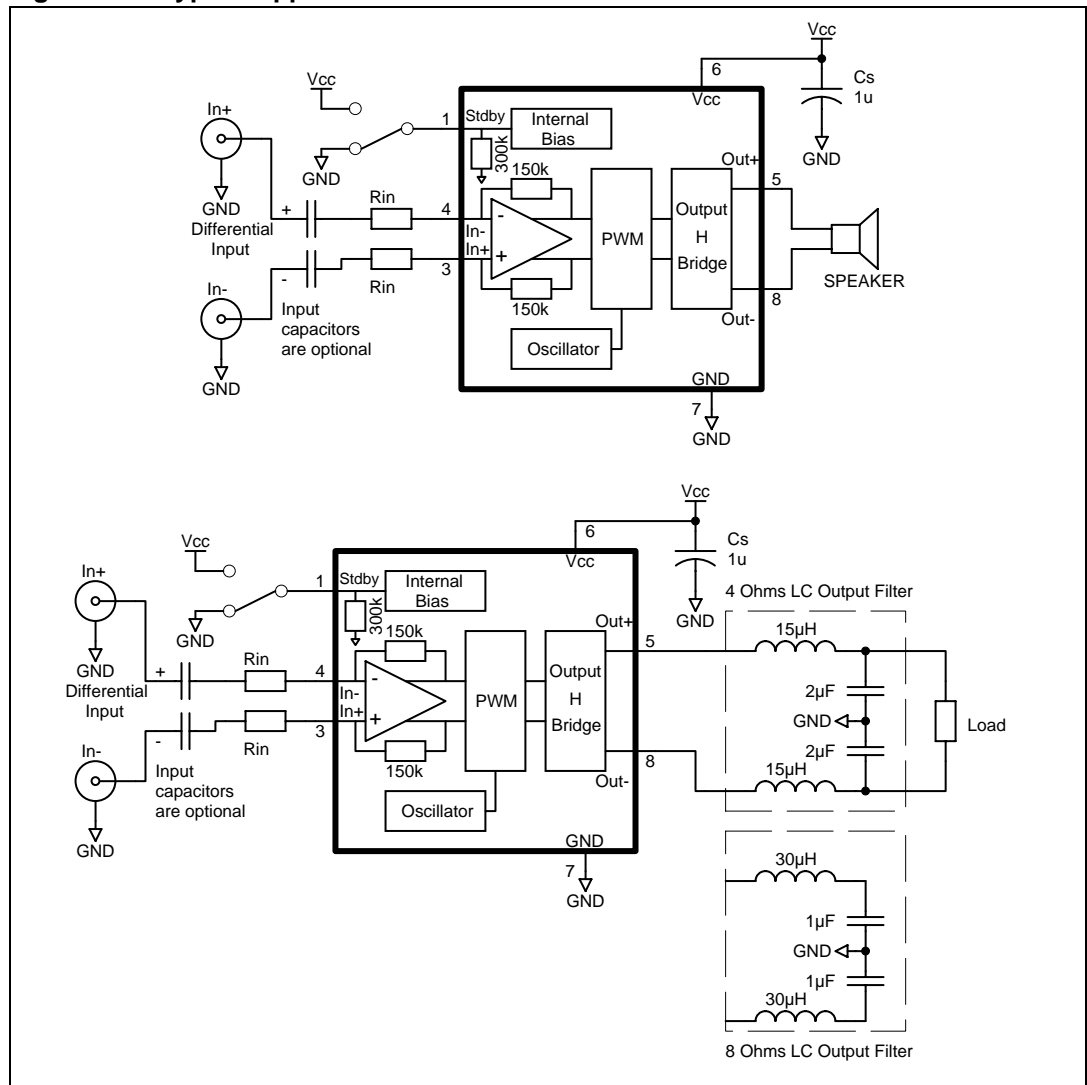



### 3 Electrical characteristics

#### 3.1 Electrical characteristics tables

**Table 5. Electrical characteristics at  $V_{CC} = +5V$ , with  $GND = 0V$ ,  $V_{icm} = 2.5V$ , and  $T_{amb} = 25^{\circ}C$  (unless otherwise specified)**

Symbol	Parameter	Min.	Typ.	Max.	Unit
$I_{CC}$	Supply current No input signal, no load		2.3	3.3	mA
$I_{STBY}$	Standby current <sup>(1)</sup> No input signal, $V_{STBY} = GND$		10	1000	nA
$V_{oo}$	Output offset voltage No input signal, $R_L = 8\Omega$		3	25	mV
$P_{out}$	Output power, G=6dB THD = 1% Max, $f = 1kHz$ , $R_L = 4\Omega$ THD = 10% Max, $f = 1kHz$ , $R_L = 4\Omega$ THD = 1% Max, $f = 1kHz$ , $R_L = 8\Omega$ THD = 10% Max, $f = 1kHz$ , $R_L = 8\Omega$		2.2 2.8 1.4 1.7		W
THD + N	Total harmonic distortion + noise $P_{out} = 850 mW_{RMS}$ , G = 6dB, $20Hz < f < 20kHz$ $R_L = 8\Omega + 15\mu H$ , BW < 30kHz $P_{out} = 1W_{RMS}$ , G = 6dB, $f = 1kHz$ $R_L = 8\Omega + 15\mu H$ , BW < 30kHz		2 0.4		%
Efficiency	Efficiency $P_{out} = 2 W_{RMS}$ , $R_L = 4\Omega + \geq 15\mu H$ $P_{out} = 1.2 W_{RMS}$ , $R_L = 8\Omega + \geq 15\mu H$		78 88		%
PSRR	Power supply rejection ratio with inputs grounded <sup>(2)</sup> $f = 217Hz$ , $R_L = 8\Omega$ , G=6dB, $V_{ripple} = 200mV_{pp}$		63		dB
CMRR	Common mode rejection ratio $f = 217Hz$ , $R_L = 8\Omega$ , G = 6dB, $\Delta V_{ic} = 200mV_{pp}$		57		dB
Gain	Gain value ( $R_{in}$ in $k\Omega$ )	$\frac{273k\Omega}{R_{in}}$	$\frac{300k\Omega}{R_{in}}$	$\frac{327k\Omega}{R_{in}}$	V/V
$R_{STBY}$	Internal resistance from standby to GND	273	300	327	$k\Omega$
$F_{PWM}$	Pulse width modulator base frequency	200	280	360	kHz
SNR	Signal to noise ratio (A weighting), $P_{out} = 1.2W$ , $R_L = 8\Omega$		85		dB
$t_{WU}$	Wake-up time		5	10	ms
$t_{STBY}$	Standby time		5	10	ms

**Table 5. Electrical characteristics at  $V_{CC} = +5V$ , with  $GND = 0V$ ,  $V_{icm} = 2.5V$ , and  $T_{amb} = 25^{\circ}C$  (unless otherwise specified) (continued)**

Symbol	Parameter	Min.	Typ.	Max.	Unit
$V_N$	Output voltage noise $f = 20Hz$ to $20kHz$ , $G = 6dB$				$\mu V_{RMS}$
	Unweighted $R_L = 4\Omega$		85		
	A-weighted $R_L = 4\Omega$		60		
	Unweighted $R_L = 8\Omega$		86		
	A-weighted $R_L = 8\Omega$		62		
	Unweighted $R_L = 4\Omega + 15\mu H$		83		
	A-weighted $R_L = 4\Omega + 15\mu H$		60		
	Unweighted $R_L = 4\Omega + 30\mu H$		88		
	A-weighted $R_L = 4\Omega + 30\mu H$		64		
	Unweighted $R_L = 8\Omega + 30\mu H$		78		
	A-weighted $R_L = 8\Omega + 30\mu H$		57		
	Unweighted $R_L = 4\Omega + Filter$		87		
	A-weighted $R_L = 4\Omega + Filter$		65		
	Unweighted $R_L = 4\Omega + Filter$		82		
A-weighted $R_L = 4\Omega + Filter$		59			

- Standby mode is active when  $V_{STBY}$  is tied to GND.
- Dynamic measurements -  $20 \cdot \log(\text{rms}(V_{out})/\text{rms}(V_{ripple}))$ .  $V_{ripple}$  is the superimposed sinusoidal signal to  $V_{CC}$  @  $f = 217Hz$ .

**Table 6. Electrical characteristics at  $V_{CC} = +4.2V$  with  $GND = 0V$ ,  $V_{icm} = 2.1V$ , and  $T_{amb} = 25^{\circ}C$  (unless otherwise specified)<sup>(1)</sup>**

Symbol	Parameter	Min.	Typ.	Max.	Unit
$I_{CC}$	Supply current No input signal, no load		2.1	3	mA
$I_{STBY}$	Standby current <sup>(2)</sup> No input signal, $V_{STBY} = GND$		10	1000	nA
$V_{oo}$	Output offset voltage No input signal, $R_L = 8\Omega$		3	25	mV
$P_{out}$	Output power, $G=6dB$ THD = 1% Max, $f = 1kHz$ , $R_L = 4\Omega$ THD = 10% Max, $f = 1kHz$ , $R_L = 4\Omega$ THD = 1% Max, $f = 1kHz$ , $R_L = 8\Omega$ THD = 10% Max, $f = 1kHz$ , $R_L = 8\Omega$		1.5 1.95 0.9 1.1		W
THD + N	Total harmonic distortion + noise $P_{out} = 600 mW_{RMS}$ , $G = 6dB$ , $20Hz < f < 20kHz$ $R_L = 8\Omega + 15\mu H$ , $BW < 30kHz$ $P_{out} = 700mW_{RMS}$ , $G = 6dB$ , $f = 1kHz$ $R_L = 8\Omega + 15\mu H$ , $BW < 30kHz$		2 0.35		%
Efficiency	Efficiency $P_{out} = 1.45 W_{RMS}$ , $R_L = 4\Omega + \geq 15\mu H$ $P_{out} = 0.9 W_{RMS}$ , $R_L = 8\Omega + \geq 15\mu H$		78 88		%
PSRR	Power supply rejection ratio with inputs grounded <sup>(3)</sup> $f = 217Hz$ , $R_L = 8\Omega$ , $G=6dB$ , $V_{ripple} = 200mV_{pp}$		63		dB
CMRR	Common mode rejection ratio $f = 217Hz$ , $R_L = 8\Omega$ , $G = 6dB$ , $\Delta V_{ic} = 200mV_{pp}$		57		dB
Gain	Gain value ( $R_{in}$ in $k\Omega$ )	$\frac{273k\Omega}{R_{in}}$	$\frac{300k\Omega}{R_{in}}$	$\frac{327k\Omega}{R_{in}}$	V/V
$R_{STBY}$	Internal resistance from standby to GND	273	300	327	$k\Omega$
$F_{PWM}$	Pulse width modulator base frequency	200	280	360	kHz
SNR	Signal to noise ratio (A-weighting) $P_{out} = 0.8W$ , $R_L = 8\Omega$		85		dB
$t_{WU}$	Wake-up time		5	10	ms
$t_{STBY}$	Standby time		5	10	ms

**Table 6. Electrical characteristics at  $V_{CC} = +4.2V$  with  $GND = 0V$ ,  $V_{icm} = 2.1V$ , and  $T_{amb} = 25^{\circ}C$  (unless otherwise specified)<sup>(1)</sup> (continued)**

Symbol	Parameter	Min.	Typ.	Max.	Unit
$V_N$	Output voltage noise $f = 20Hz$ to $20kHz$ , $G = 6dB$				$\mu V_{RMS}$
	Unweighted $R_L = 4\Omega$		85		
	A-weighted $R_L = 4\Omega$		60		
	Unweighted $R_L = 8\Omega$		86		
	A-weighted $R_L = 8\Omega$		62		
	Unweighted $R_L = 4\Omega + 15\mu H$		83		
	A-weighted $R_L = 4\Omega + 15\mu H$		60		
	Unweighted $R_L = 4\Omega + 30\mu H$		88		
	A-weighted $R_L = 4\Omega + 30\mu H$		64		
	Unweighted $R_L = 8\Omega + 30\mu H$		78		
	A-weighted $R_L = 8\Omega + 30\mu H$		57		
	Unweighted $R_L = 4\Omega + Filter$		87		
	A-weighted $R_L = 4\Omega + Filter$		65		
	Unweighted $R_L = 4\Omega + Filter$		82		
A-weighted $R_L = 4\Omega + Filter$		59			

1. All electrical values are guaranteed with correlation measurements at 2.5V and 5V.
2. Standby mode is active when  $V_{STBY}$  is tied to GND.
3. Dynamic measurements -  $20 \cdot \log(\text{rms}(V_{out})/\text{rms}(V_{ripple}))$ .  $V_{ripple}$  is the superimposed sinusoidal signal to  $V_{CC}$  @  $f = 217Hz$ .

**Table 7. Electrical characteristics at  $V_{CC} = +3.6V$   
with  $GND = 0V$ ,  $V_{icm} = 1.8V$ ,  $T_{amb} = 25^{\circ}C$  (unless otherwise specified)<sup>(1)</sup>**

Symbol	Parameter	Min.	Typ.	Max.	Unit
$I_{CC}$	Supply current No input signal, no load		2	2.8	mA
$I_{STBY}$	Standby current <sup>(2)</sup> No input signal, $V_{STBY} = GND$		10	1000	nA
$V_{oo}$	Output offset voltage No input signal, $R_L = 8\Omega$		3	25	mV
$P_{out}$	Output power, G=6dB THD = 1% Max, f = 1kHz, $R_L = 4\Omega$ THD = 10% Max, f = 1kHz, $R_L = 4\Omega$ THD = 1% Max, f = 1kHz, $R_L = 8\Omega$ THD = 10% Max, f = 1kHz, $R_L = 8\Omega$		1.1 1.4 0.7 0.85		W
THD + N	Total harmonic distortion + noise $P_{out} = 450\text{ mW}_{RMS}$ , G = 6dB, 20Hz < f < 20kHz $R_L = 8\Omega + 15\mu H$ , BW < 30kHz $P_{out} = 500\text{ mW}_{RMS}$ , G = 6dB, f = 1kHz $R_L = 8\Omega + 15\mu H$ , BW < 30kHz		2 0.1		%
Efficiency	Efficiency $P_{out} = 1\text{ W}_{RMS}$ , $R_L = 4\Omega + \geq 15\mu H$ $P_{out} = 0.65\text{ W}_{RMS}$ , $R_L = 8\Omega + \geq 15\mu H$		78 88		%
PSRR	Power supply rejection ratio with inputs grounded <sup>(3)</sup> f = 217Hz, $R_L = 8\Omega$ , G=6dB, $V_{ripple} = 200\text{ mV}_{pp}$		62		dB
CMRR	Common mode rejection ratio f = 217Hz, $R_L = 8\Omega$ , G = 6dB, $\Delta V_{ic} = 200\text{ mV}_{pp}$		56		dB
Gain	Gain value ( $R_{in}$ in k $\Omega$ )	$\frac{273\text{ k}\Omega}{R_{in}}$	$\frac{300\text{ k}\Omega}{R_{in}}$	$\frac{327\text{ k}\Omega}{R_{in}}$	V/V
$R_{STBY}$	Internal resistance from standby to GND	273	300	327	k $\Omega$
$F_{PWM}$	Pulse width modulator base frequency	200	280	360	kHz
SNR	Signal to noise ratio (A-weighting) $P_{out} = 0.6W$ , $R_L = 8\Omega$		83		dB
$t_{WU}$	Wake-up time		5	10	ms
$t_{STBY}$	Standby time		5	10	ms

**Table 7. Electrical characteristics at  $V_{CC} = +3.6V$  with  $GND = 0V$ ,  $V_{icm} = 1.8V$ ,  $T_{amb} = 25^{\circ}C$  (unless otherwise specified)<sup>(1)</sup> (continued)**

Symbol	Parameter	Min.	Typ.	Max.	Unit
$V_N$	Output voltage noise $f = 20Hz$ to $20kHz$ , $G = 6dB$				$\mu V_{RMS}$
	Unweighted $R_L = 4\Omega$		83		
	A-weighted $R_L = 4\Omega$		57		
	Unweighted $R_L = 8\Omega$		83		
	A-weighted $R_L = 8\Omega$		61		
	Unweighted $R_L = 4\Omega + 15\mu H$		81		
	A-weighted $R_L = 4\Omega + 15\mu H$		58		
	Unweighted $R_L = 4\Omega + 30\mu H$		87		
	A-weighted $R_L = 4\Omega + 30\mu H$		62		
	Unweighted $R_L = 8\Omega + 30\mu H$		77		
	A-weighted $R_L = 8\Omega + 30\mu H$		56		
	Unweighted $R_L = 4\Omega + Filter$		85		
	A-weighted $R_L = 4\Omega + Filter$		63		
	Unweighted $R_L = 4\Omega + Filter$		80		
A-weighted $R_L = 4\Omega + Filter$		57			

1. All electrical values are guaranteed with correlation measurements at 2.5V and 5V.
2. Standby mode is activated when  $V_{STBY}$  is tied to GND.
3. Dynamic measurements -  $20 \cdot \log(\text{rms}(V_{out})/\text{rms}(V_{ripple}))$ .  $V_{ripple}$  is the superimposed sinusoidal signal to  $V_{CC}$  @  $f = 217Hz$ .

**Table 8. Electrical characteristics at  $V_{CC} = +3.0V$   
with  $GND = 0V$ ,  $V_{icm} = 1.5V$ ,  $T_{amb} = 25^{\circ}C$  (unless otherwise specified)<sup>(1)</sup>**

Symbol	Parameter	Min.	Typ.	Max.	Unit
$I_{CC}$	Supply current No input signal, no load		1.9	2.7	mA
$I_{STBY}$	Standby current <sup>(2)</sup> No input signal, $V_{STBY} = GND$		10	1000	nA
$V_{oo}$	Output offset voltage No input signal, $R_L = 8\Omega$		3	25	mV
$P_{out}$	Output power, $G=6dB$ THD = 1% Max, $f = 1kHz$ , $R_L = 4\Omega$ THD = 10% Max, $f = 1kHz$ , $R_L = 4\Omega$ THD = 1% Max, $f = 1kHz$ , $R_L = 8\Omega$ THD = 10% Max, $f = 1kHz$ , $R_L = 8\Omega$		0.7 1 0.5 0.6		W
THD + N	Total harmonic distortion + noise $P_{out} = 300\text{ mW}_{RMS}$ , $G = 6dB$ , $20Hz < f < 20kHz$ $R_L = 8\Omega + 15\mu H$ , $BW < 30kHz$ $P_{out} = 350\text{ mW}_{RMS}$ , $G = 6dB$ , $f = 1kHz$ $R_L = 8\Omega + 15\mu H$ , $BW < 30kHz$		2 0.1		%
Efficiency	Efficiency $P_{out} = 0.7\text{ W}_{RMS}$ , $R_L = 4\Omega + \geq 15\mu H$ $P_{out} = 0.45\text{ W}_{RMS}$ , $R_L = 8\Omega + \geq 15\mu H$		78 88		%
PSRR	Power supply rejection ratio with inputs grounded <sup>(3)</sup> $f = 217Hz$ , $R_L = 8\Omega$ , $G=6dB$ , $V_{ripple} = 200\text{mV}_{pp}$		60		dB
CMRR	Common mode rejection ratio $f = 217Hz$ , $R_L = 8\Omega$ , $G = 6dB$ , $\Delta V_{ic} = 200\text{mV}_{pp}$		54		dB
Gain	Gain value ( $R_{in}$ in $k\Omega$ )	$\frac{273k\Omega}{R_{in}}$	$\frac{300k\Omega}{R_{in}}$	$\frac{327k\Omega}{R_{in}}$	V/V
$R_{STBY}$	Internal resistance from standby to GND	273	300	327	$k\Omega$
$F_{PWM}$	Pulse width modulator base frequency	200	280	360	kHz
SNR	Signal to noise ratio (A-weighting) $P_{out} = 0.4W$ , $R_L = 8\Omega$		82		dB
$t_{WU}$	Wake-up time		5	10	ms
$t_{STBY}$	Standby time		5	10	ms

**Table 8. Electrical characteristics at  $V_{CC} = +3.0V$  with  $GND = 0V$ ,  $V_{icm} = 1.5V$ ,  $T_{amb} = 25^{\circ}C$  (unless otherwise specified)<sup>(1)</sup> (continued)**

Symbol	Parameter	Min.	Typ.	Max.	Unit
$V_N$	Output voltage noise $f = 20Hz$ to $20kHz$ , $G = 6dB$				$\mu V_{RMS}$
	Unweighted $R_L = 4\Omega$		83		
	A-weighted $R_L = 4\Omega$		57		
	Unweighted $R_L = 8\Omega$		83		
	A-weighted $R_L = 8\Omega$		61		
	Unweighted $R_L = 4\Omega + 15\mu H$		81		
	A-weighted $R_L = 4\Omega + 15\mu H$		58		
	Unweighted $R_L = 4\Omega + 30\mu H$		87		
	A-weighted $R_L = 4\Omega + 30\mu H$		62		
	Unweighted $R_L = 8\Omega + 30\mu H$		77		
	A-weighted $R_L = 8\Omega + 30\mu H$		56		
	Unweighted $R_L = 4\Omega + Filter$		85		
	A-weighted $R_L = 4\Omega + Filter$		63		
	Unweighted $R_L = 4\Omega + Filter$		80		
A-weighted $R_L = 4\Omega + Filter$		57			

1. All electrical values are guaranteed with correlation measurements at 2.5V and 5V.
2. Standby mode is active when  $V_{STBY}$  is tied to GND.
3. Dynamic measurements -  $20 \cdot \log(\text{rms}(V_{out})/\text{rms}(V_{ripple}))$ .  $V_{ripple}$  is the superimposed sinusoidal signal to  $V_{CC}$  @  $f = 217Hz$ .



**Table 9. Electrical characteristics at  $V_{CC} = +2.5V$   
with  $GND = 0V$ ,  $V_{icm} = 1.25V$ ,  $T_{amb} = 25^{\circ}C$  (unless otherwise specified)**

Symbol	Parameter	Min.	Typ.	Max.	Unit
$I_{CC}$	Supply current No input signal, no load		1.7	2.4	mA
$I_{STBY}$	Standby current <sup>(1)</sup> No input signal, $V_{STBY} = GND$		10	1000	nA
$V_{oo}$	Output offset voltage No input signal, $R_L = 8\Omega$		3	25	mV
$P_{out}$	Output power, $G=6dB$ THD = 1% Max, $f = 1kHz$ , $R_L = 4\Omega$ THD = 10% Max, $f = 1kHz$ , $R_L = 4\Omega$ THD = 1% Max, $f = 1kHz$ , $R_L = 8\Omega$ THD = 10% Max, $f = 1kHz$ , $R_L = 8\Omega$		0.5 0.65 0.33 0.41		W
THD + N	Total harmonic distortion + noise $P_{out} = 180 mW_{RMS}$ , $G = 6dB$ , $20Hz < f < 20kHz$ $R_L = 8\Omega + 15\mu H$ , $BW < 30kHz$ $P_{out} = 200mW_{RMS}$ , $G = 6dB$ , $f = 1kHz$ $R_L = 8\Omega + 15\mu H$ , $BW < 30kHz$		1 0.05		%
Efficiency	Efficiency $P_{out} = 0.47 W_{RMS}$ , $R_L = 4\Omega + \geq 15\mu H$ $P_{out} = 0.3 W_{RMS}$ , $R_L = 8\Omega + \geq 15\mu H$		78 88		%
PSRR	Power supply rejection ratio with inputs grounded <sup>(2)</sup> $f = 217Hz$ , $R_L = 8\Omega$ , $G=6dB$ , $V_{ripple} = 200mV_{pp}$		60		dB
CMRR	Common mode rejection ratio $f = 217Hz$ , $R_L = 8\Omega$ , $G = 6dB$ , $\Delta V_{ic} = 200mV_{pp}$		54		dB
Gain	Gain value ( $R_{in}$ in $k\Omega$ )	$\frac{273k\Omega}{R_{in}}$	$\frac{300k\Omega}{R_{in}}$	$\frac{327k\Omega}{R_{in}}$	V/V
$R_{STBY}$	Internal resistance from standby to GND	273	300	327	$k\Omega$
$F_{PWM}$	Pulse width modulator base frequency	200	280	360	kHz
SNR	Signal to noise ratio (A-weighting) $P_{out} = 0.3W$ , $R_L = 8\Omega$		80		dB
$t_{WU}$	Wake-up time		5	10	ms
$t_{STBY}$	Standby time		5	10	ms

**Table 9. Electrical characteristics at  $V_{CC} = +2.5V$  with  $GND = 0V$ ,  $V_{icm} = 1.25V$ ,  $T_{amb} = 25^{\circ}C$  (unless otherwise specified) (continued)**

Symbol	Parameter	Min.	Typ.	Max.	Unit
$V_N$	Output voltage noise $f = 20Hz$ to $20kHz$ , $G = 6dB$				$\mu V_{RMS}$
	Unweighted $R_L = 4\Omega$		85		
	A-weighted $R_L = 4\Omega$		60		
	Unweighted $R_L = 8\Omega$		86		
	A-weighted $R_L = 8\Omega$		62		
	Unweighted $R_L = 4\Omega + 15\mu H$		76		
	A-weighted $R_L = 4\Omega + 15\mu H$		56		
	Unweighted $R_L = 4\Omega + 30\mu H$		82		
	A-weighted $R_L = 4\Omega + 30\mu H$		60		
	Unweighted $R_L = 8\Omega + 30\mu H$		67		
	A-weighted $R_L = 8\Omega + 30\mu H$		53		
	Unweighted $R_L = 4\Omega + \text{Filter}$		78		
	A-weighted $R_L = 4\Omega + \text{Filter}$		57		
	Unweighted $R_L = 4\Omega + \text{Filter}$		74		
A-weighted $R_L = 4\Omega + \text{Filter}$		54			

- Standby mode is active when  $V_{STBY}$  is tied to GND.
- Dynamic measurements -  $20 \cdot \log(\text{rms}(V_{out})/\text{rms}(V_{ripple}))$ .  $V_{ripple}$  is the superimposed sinusoidal signal to  $V_{CC}$  @  $f = 217Hz$ .

**Table 10. Electrical characteristics at  $V_{CC} +2.4V$   
with  $GND = 0V$ ,  $V_{icm} = 1.2V$ ,  $T_{amb} = 25^{\circ}C$  (unless otherwise specified)**

Symbol	Parameter	Min.	Typ.	Max.	Unit
$I_{CC}$	Supply current No input signal, no load		1.7		mA
$I_{STBY}$	Standby current <sup>(1)</sup> No input signal, $V_{STBY} = GND$		10		nA
$V_{oo}$	Output offset voltage No input signal, $R_L = 8\Omega$		3		mV
$P_{out}$	Output power, $G=6dB$ THD = 1% Max, $f = 1kHz$ , $R_L = 4\Omega$ THD = 10% Max, $f = 1kHz$ , $R_L = 4\Omega$ THD = 1% Max, $f = 1kHz$ , $R_L = 8\Omega$ THD = 10% Max, $f = 1kHz$ , $R_L = 8\Omega$		0.42 0.61 0.3 0.38		W
THD + N	Total harmonic distortion + noise $P_{out} = 150 mW_{RMS}$ , $G = 6dB$ , $20Hz < f < 20kHz$ $R_L = 8\Omega + 15\mu H$ , $BW < 30kHz$		1		%
Efficiency	Efficiency $P_{out} = 0.38 W_{RMS}$ , $R_L = 4\Omega + \geq 15\mu H$ $P_{out} = 0.25 W_{RMS}$ , $R_L = 8\Omega + \geq 15\mu H$		77 86		%
CMRR	Common mode rejection ratio $f = 217Hz$ , $R_L = 8\Omega$ , $G = 6dB$ , $\Delta V_{ic} = 200mV_{pp}$		54		dB
Gain	Gain value ( $R_{in}$ in $k\Omega$ )	$\frac{273k\Omega}{R_{in}}$	$\frac{300k\Omega}{R_{in}}$	$\frac{327k\Omega}{R_{in}}$	V/V
$R_{STBY}$	Internal resistance from standby to GND	273	300	327	$k\Omega$
$F_{PWM}$	Pulse width modulator base frequency		280		kHz
SNR	Signal to noise ratio (A-weighting) $P_{out} = 0.25W$ , $R_L = 8\Omega$		80		dB
$t_{WU}$	Wake-up time		5		ms
$t_{STBY}$	Standby time		5		ms

**Table 10. Electrical characteristics at  $V_{CC} +2.4V$  with  $GND = 0V$ ,  $V_{icm} = 1.2V$ ,  $T_{amb} = 25^{\circ}C$  (unless otherwise specified)**

Symbol	Parameter	Min.	Typ.	Max.	Unit
$V_N$	Output voltage noise $f = 20Hz$ to $20kHz$ , $G = 6dB$				$\mu V_{RMS}$
	Unweighted $R_L = 4\Omega$		85		
	A-weighted $R_L = 4\Omega$		60		
	Unweighted $R_L = 8\Omega$		86		
	A-weighted $R_L = 8\Omega$		62		
	Unweighted $R_L = 4\Omega + 15\mu H$		76		
	A-weighted $R_L = 4\Omega + 15\mu H$		56		
	Unweighted $R_L = 4\Omega + 30\mu H$		82		
	A-weighted $R_L = 4\Omega + 30\mu H$		60		
	Unweighted $R_L = 8\Omega + 30\mu H$		67		
	A-weighted $R_L = 8\Omega + 30\mu H$		53		
	Unweighted $R_L = 4\Omega + Filter$		78		
	A-weighted $R_L = 4\Omega + Filter$		57		
	Unweighted $R_L = 4\Omega + Filter$		74		
A-weighted $R_L = 4\Omega + Filter$		54			

1. Standby mode is active when  $V_{STBY}$  is tied to GND.

### 3.2 Electrical characteristics curves

The graphs shown in this section use the following abbreviations:

- $R_L + 15\mu\text{H}$  or  $30\mu\text{H}$  = pure resistor+ very low series resistance inductor
- Filter = LC output filter ( $1\mu\text{F}+30\mu\text{H}$  for  $4\Omega$  and  $0.5\mu\text{F}+60\mu\text{H}$  for  $8\Omega$ )

All measurements are done with  $C_{S1}=1\mu\text{F}$  and  $C_{S2}=100\text{nF}$  (see [Figure 2](#)), except for the PSRR where  $C_{S1}$  is removed (see [Figure 3](#)).

**Figure 2. Schematic used for test measurements**

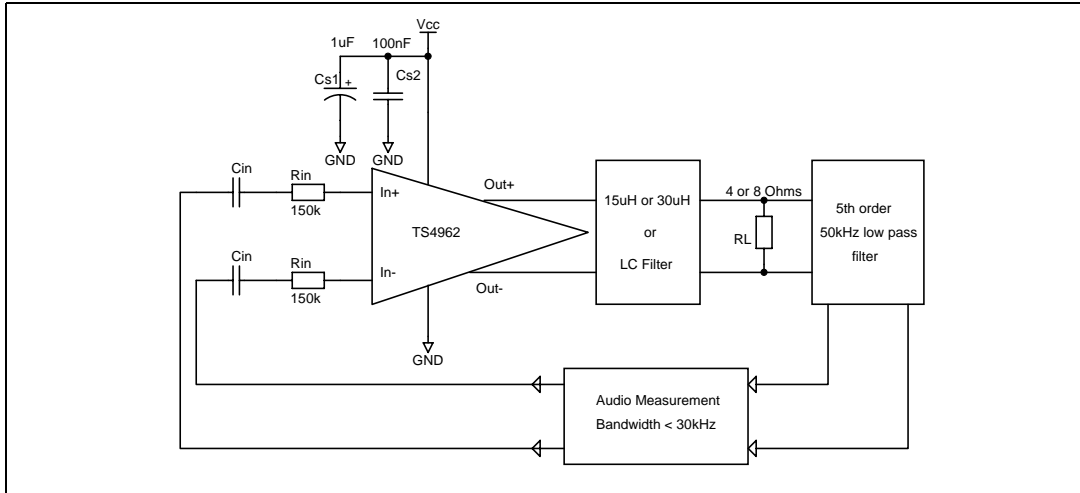

**Figure 3. Schematic used for PSSR measurements**

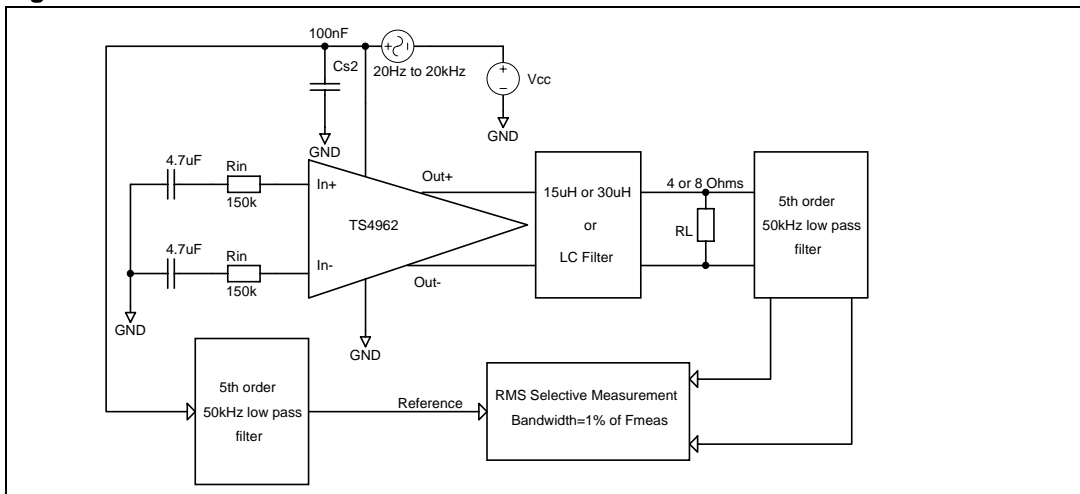

Figure 4. Current consumption vs. power supply voltage

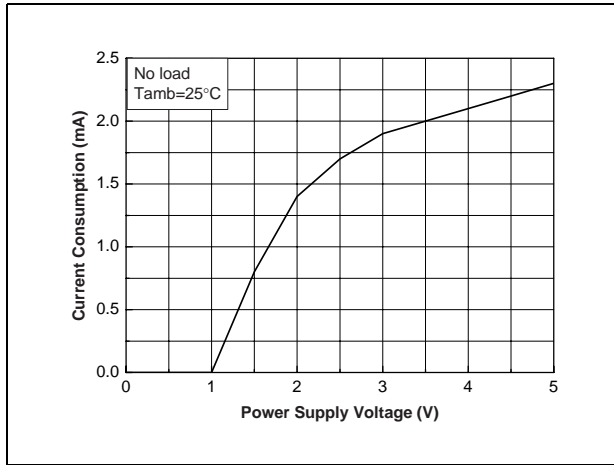

Figure 5. Current consumption vs. standby voltage

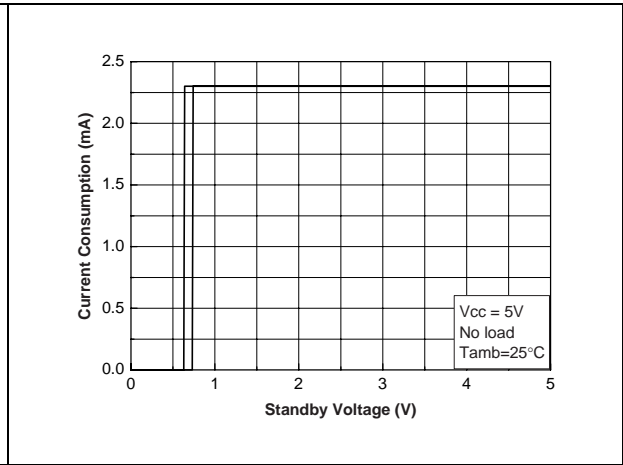

Figure 6. Current consumption vs. standby voltage

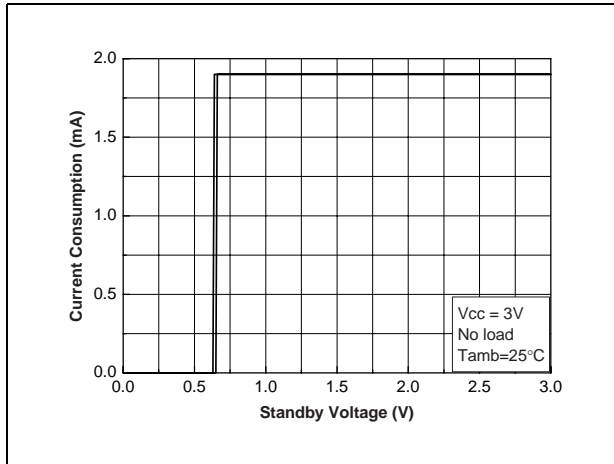

Figure 7. Output offset voltage vs. common mode input voltage

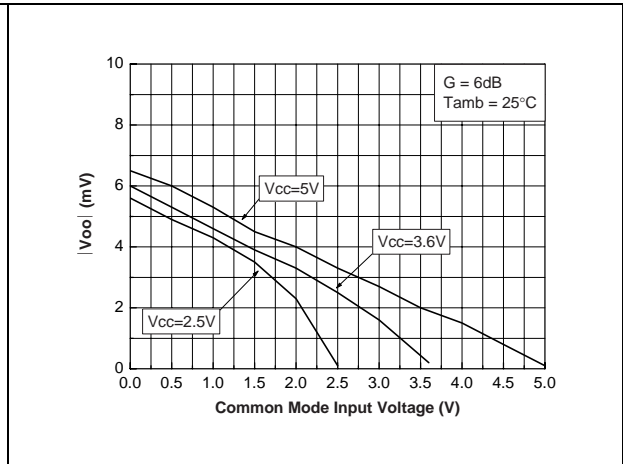

Figure 8. Efficiency vs. output power

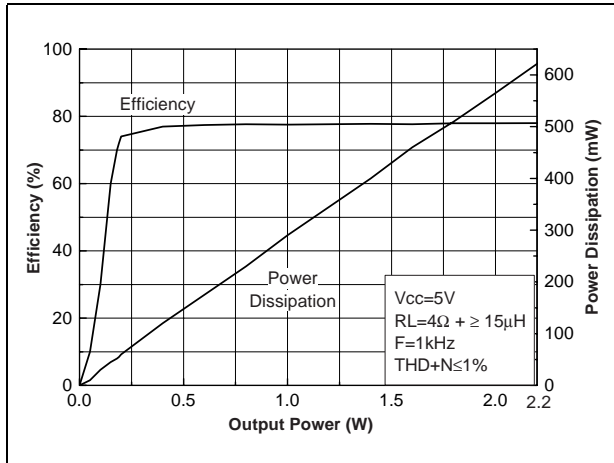

Figure 9. Efficiency vs. output power

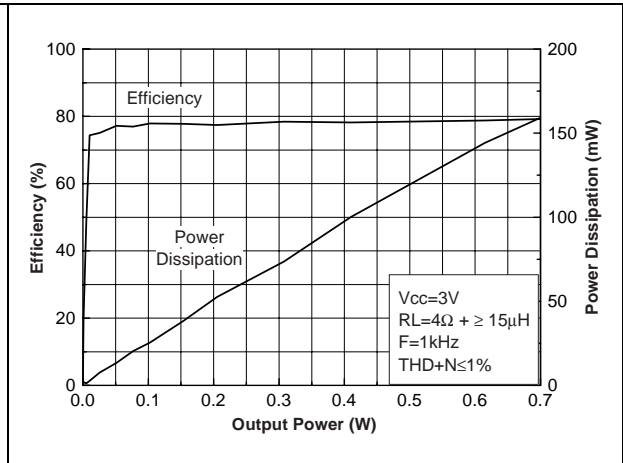

Figure 10. Efficiency vs. output power

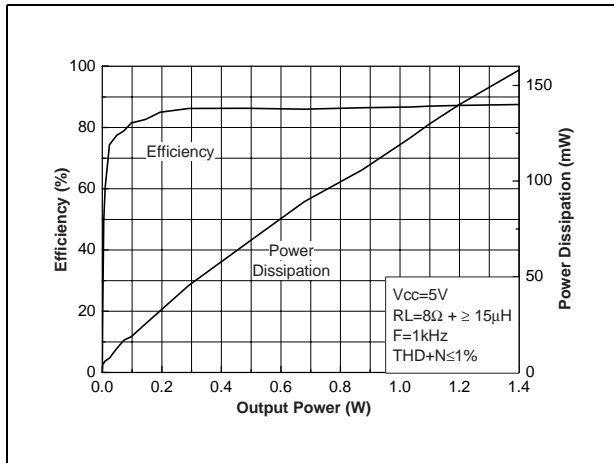

Figure 11. Efficiency vs. output power

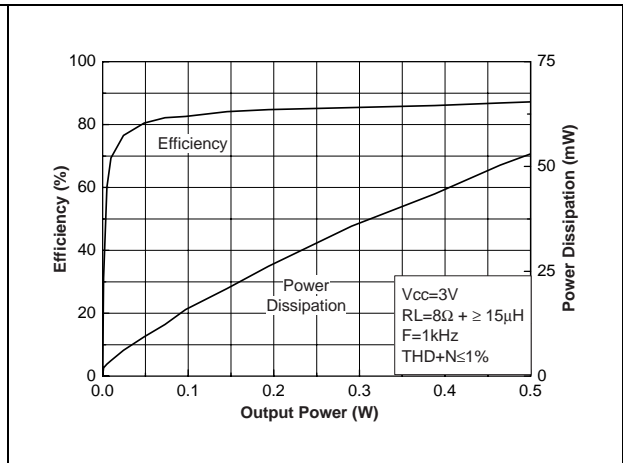

Figure 12. Output power vs. power supply voltage

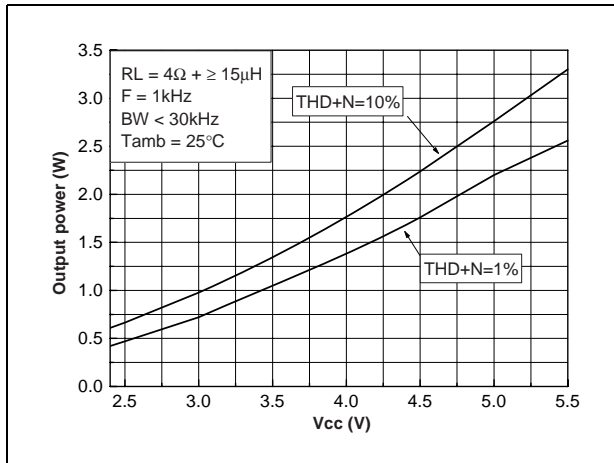

Figure 13. Output power vs. power supply voltage

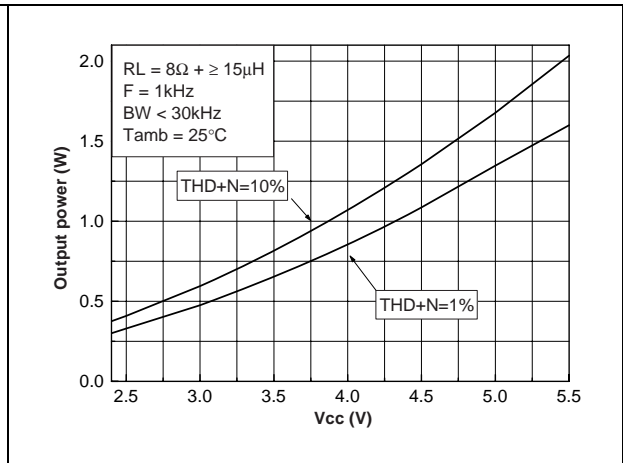

Figure 14. PSRR vs. frequency

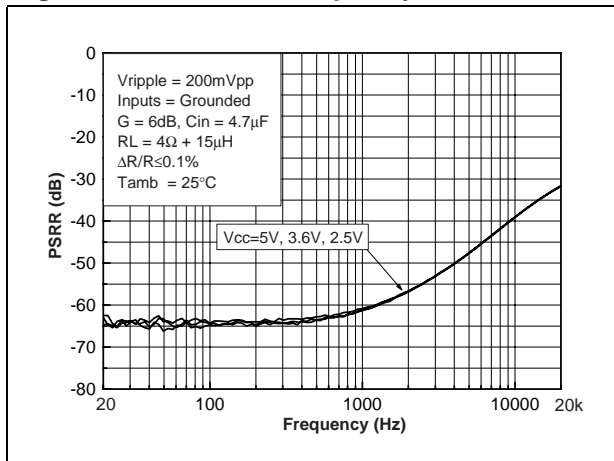

Figure 15. PSRR vs. frequency

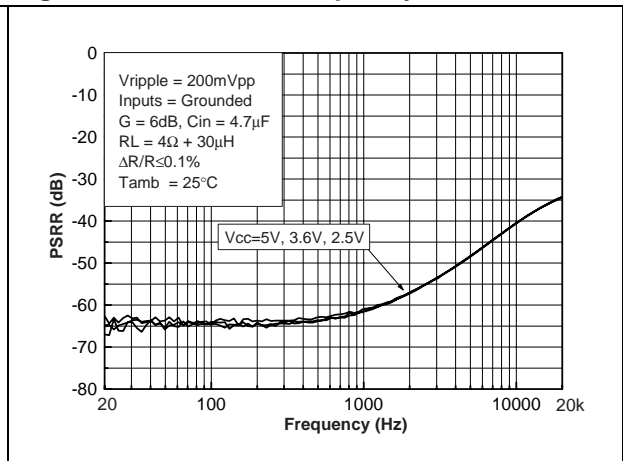

Figure 16. PSRR vs. frequency

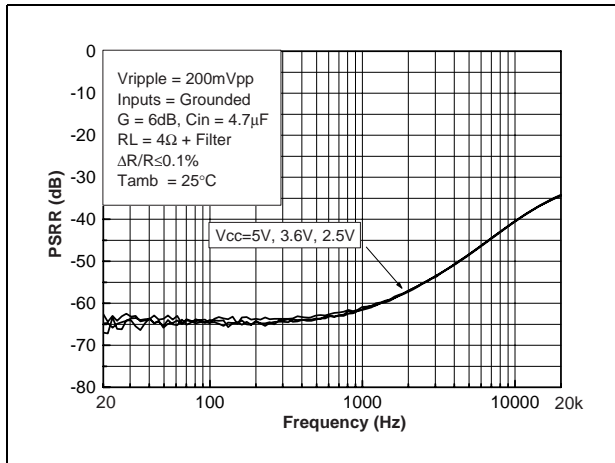

Figure 17. PSRR vs. frequency

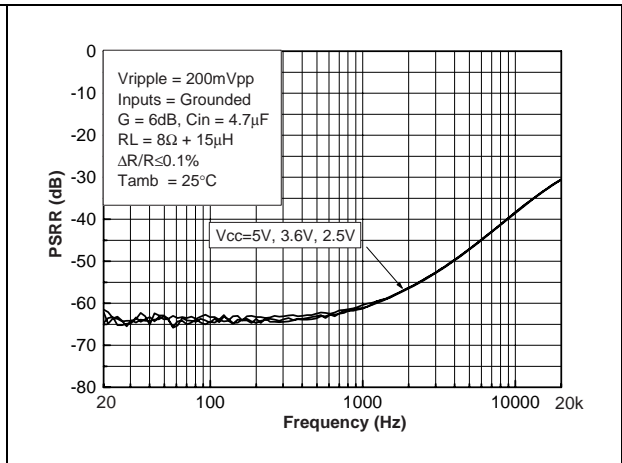

Figure 18. PSRR vs. frequency

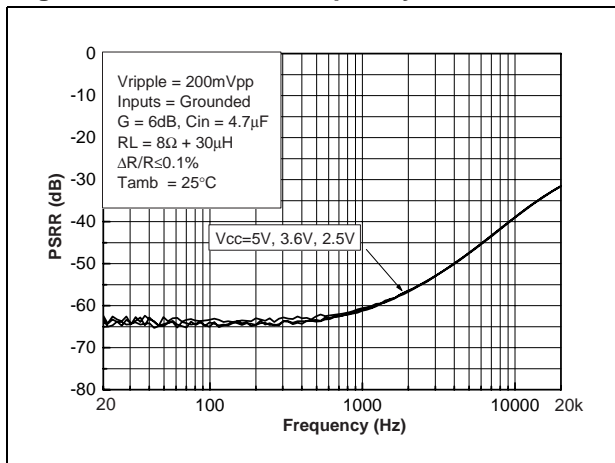

Figure 19. PSRR vs. frequency

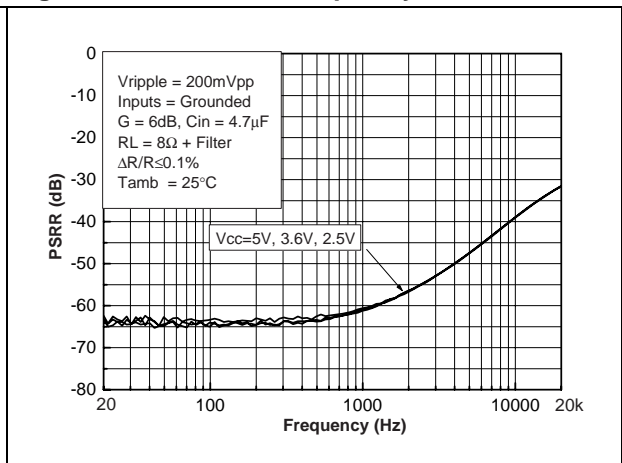

Figure 20. PSRR vs. common mode input voltage Figure 21. CMRR vs. frequency

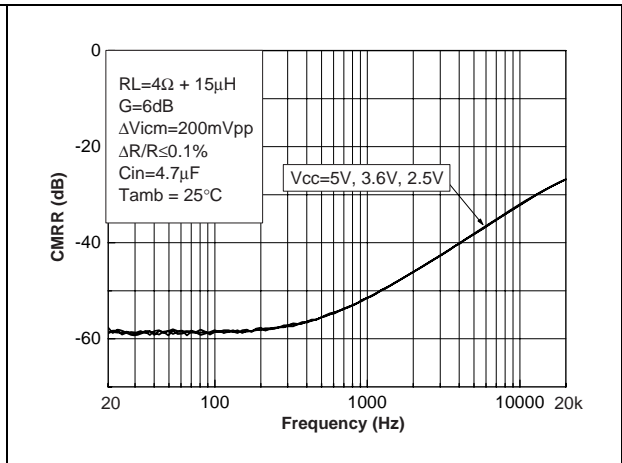
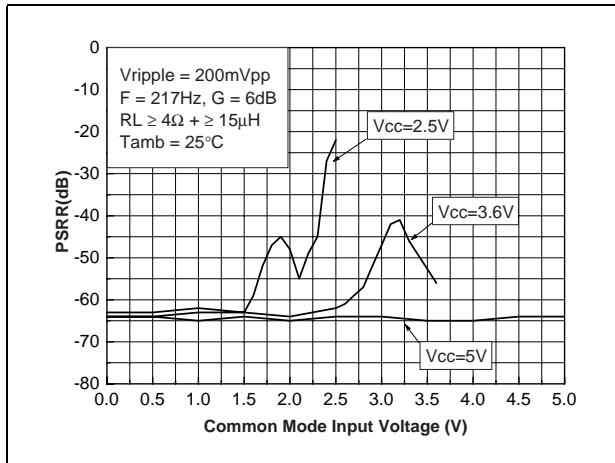



Figure 22. CMRR vs. frequency

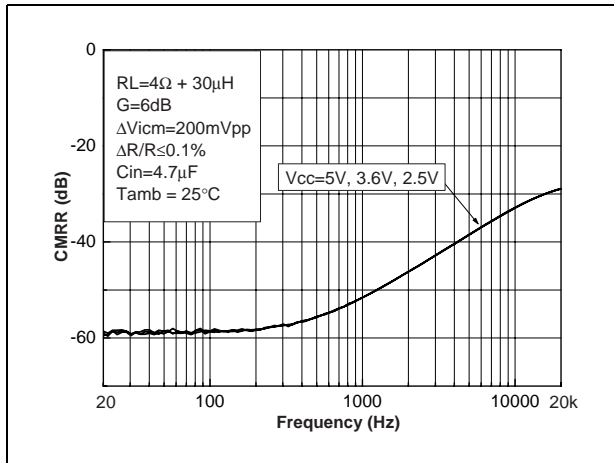

Figure 23. CMRR vs. frequency

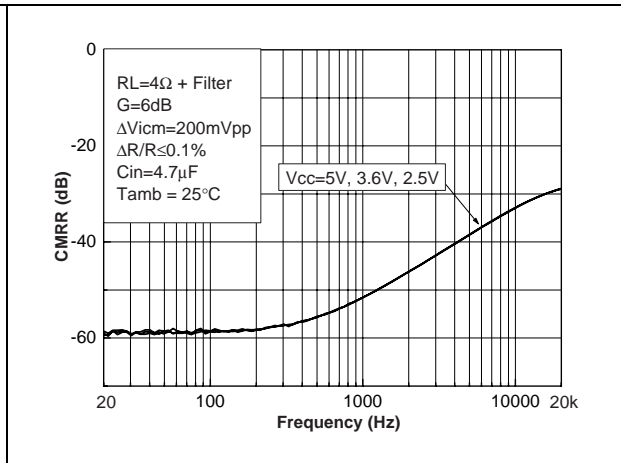

Figure 24. CMRR vs. frequency

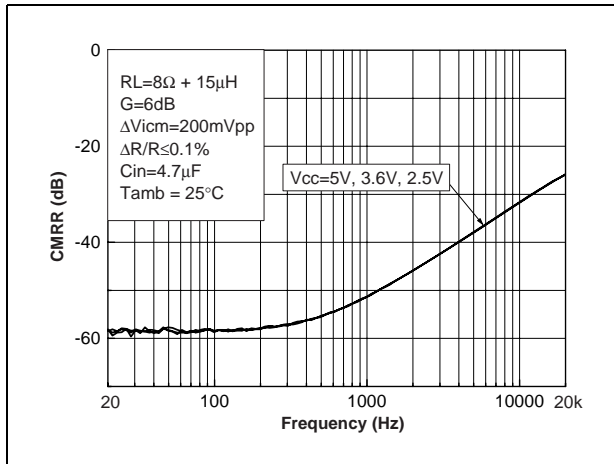

Figure 25. CMRR vs. frequency

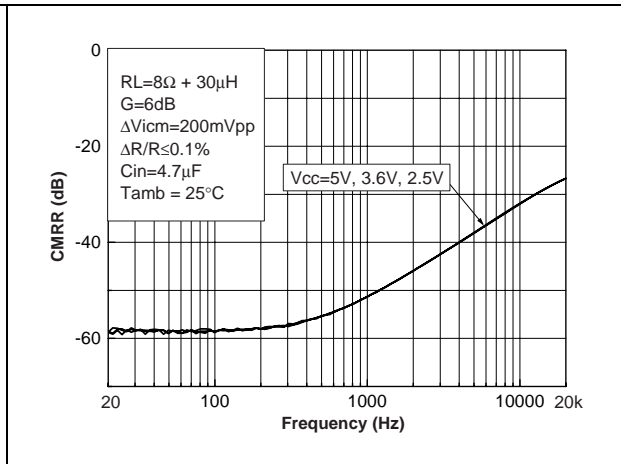

Figure 26. CMRR vs. frequency

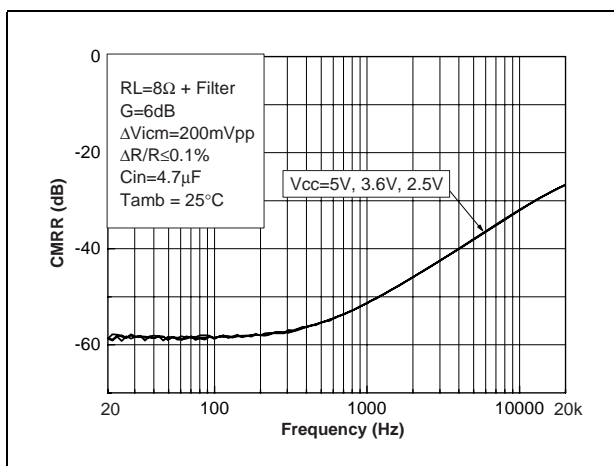

Figure 27. CMRR vs. common mode input voltage

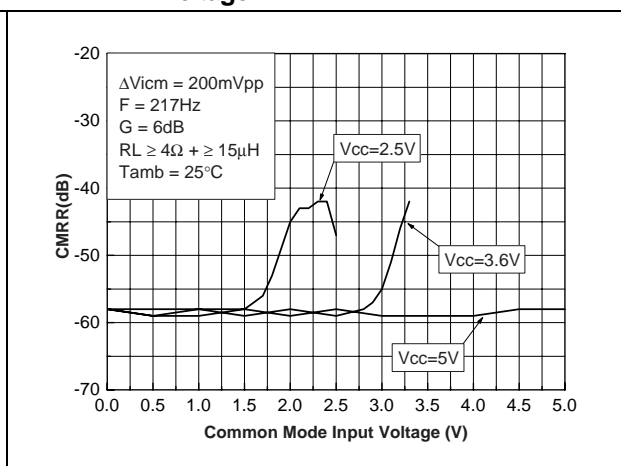

Figure 28. THD+N vs. output power

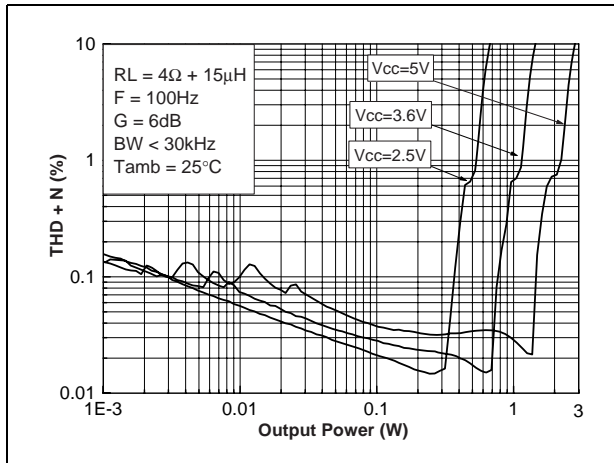

Figure 29. THD+N vs. output power

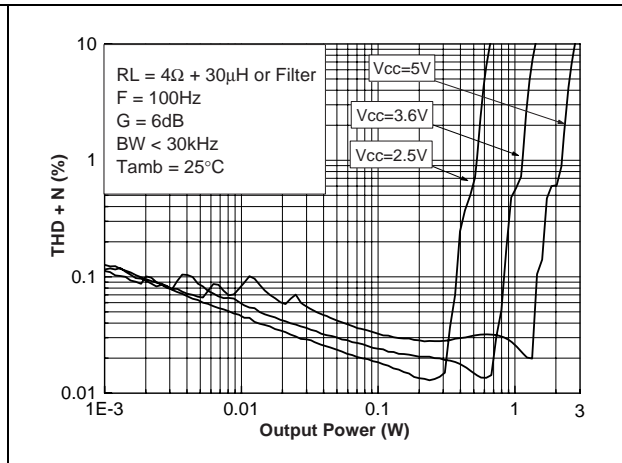

Figure 30. THD+N vs. output power

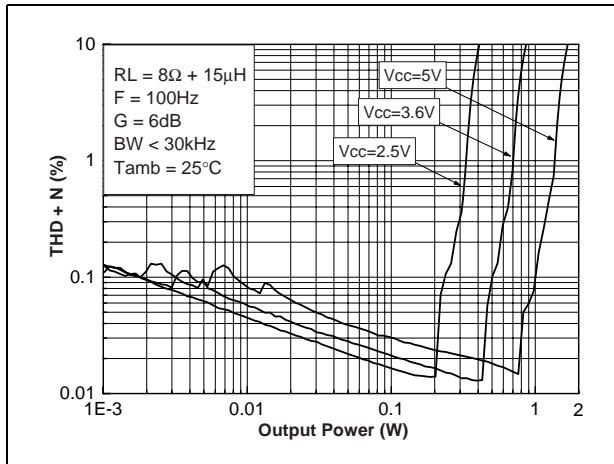

Figure 31. THD+N vs. output power

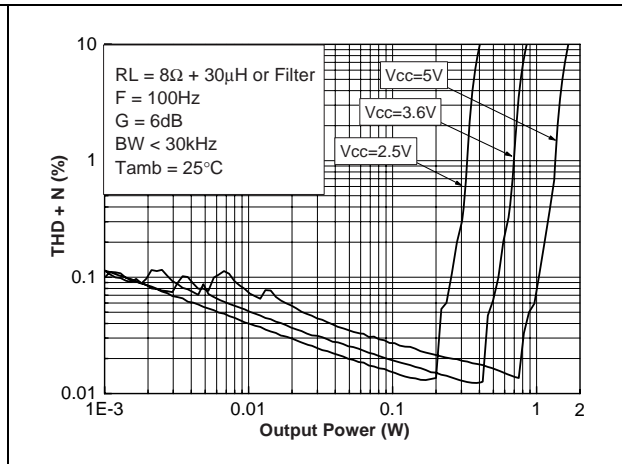

Figure 32. THD+N vs. output power

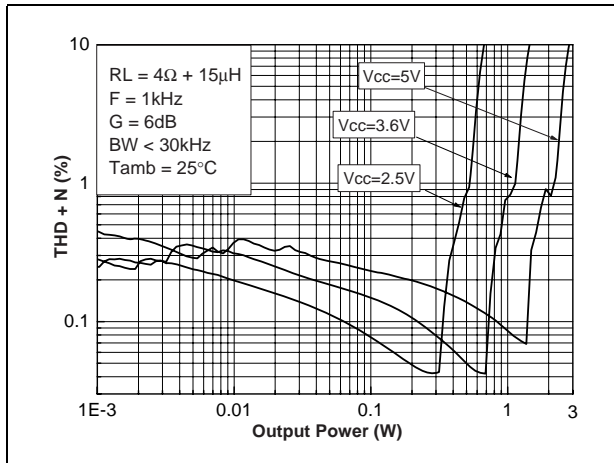

Figure 33. THD+N vs. output power

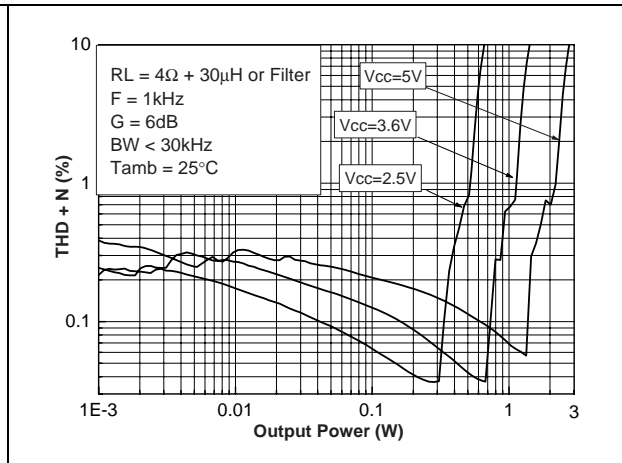

Figure 34. THD+N vs. output power

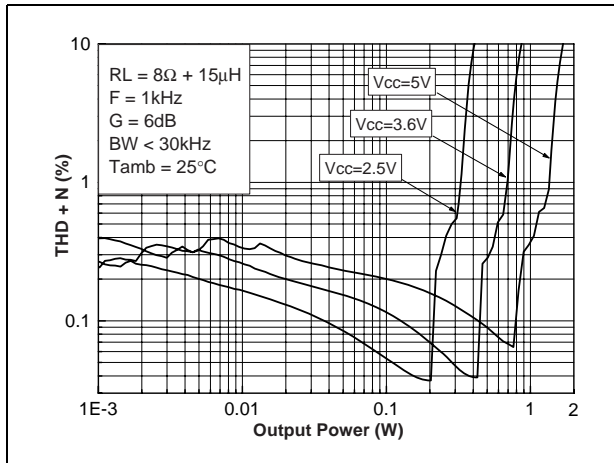

Figure 35. THD+N vs. output power

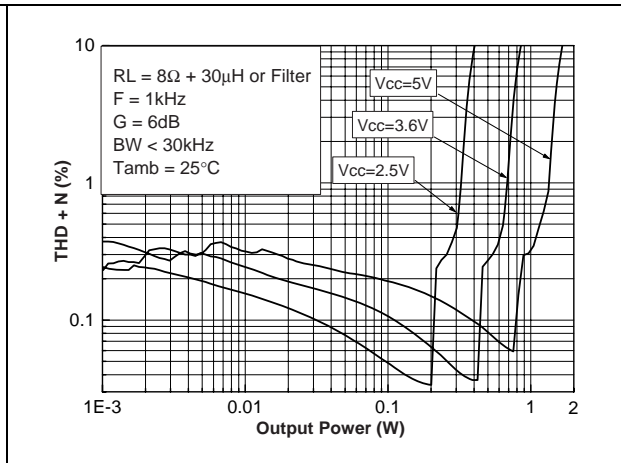

Figure 36. THD+N vs. frequency

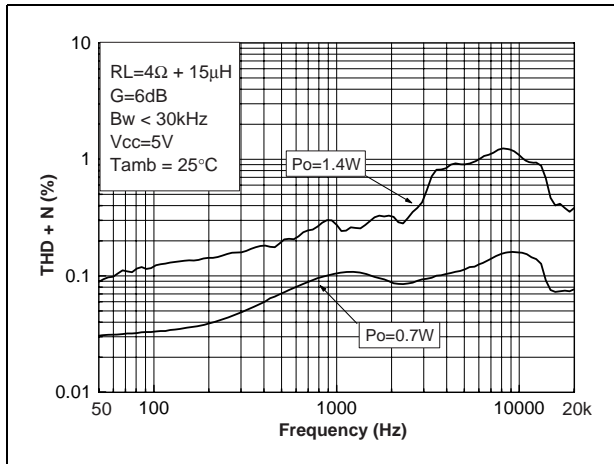

Figure 37. THD+N vs. frequency

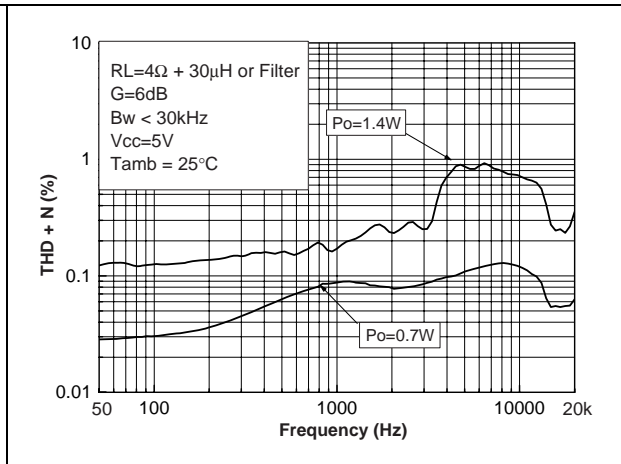

Figure 38. THD+N vs. frequency

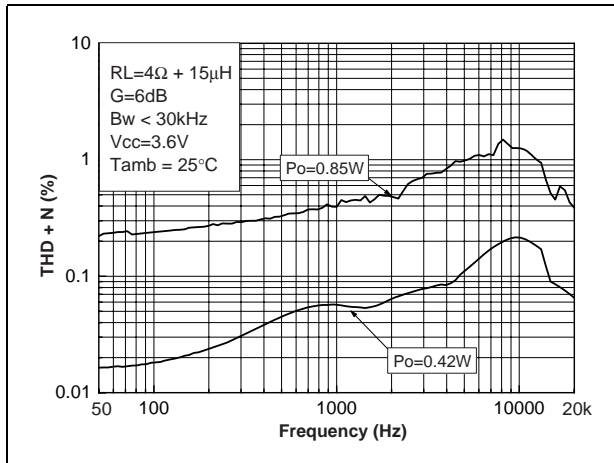

Figure 39. THD+N vs. frequency

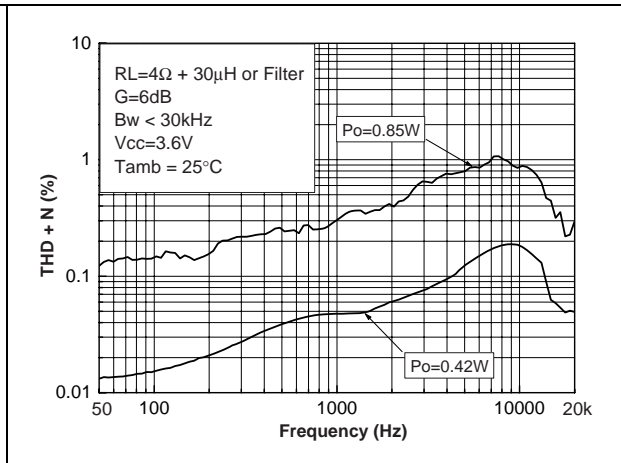

Figure 40. THD+N vs. frequency

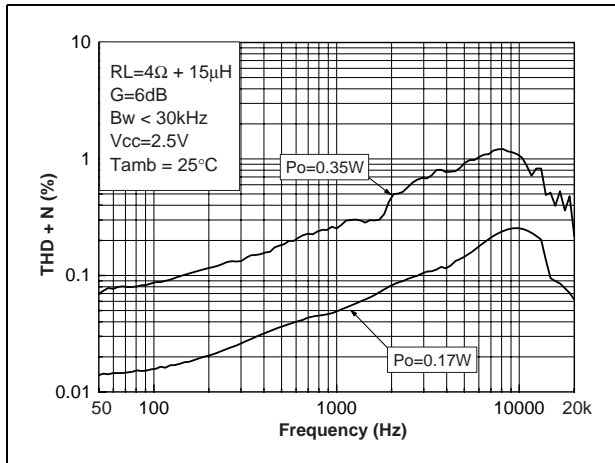

Figure 41. THD+N vs. frequency

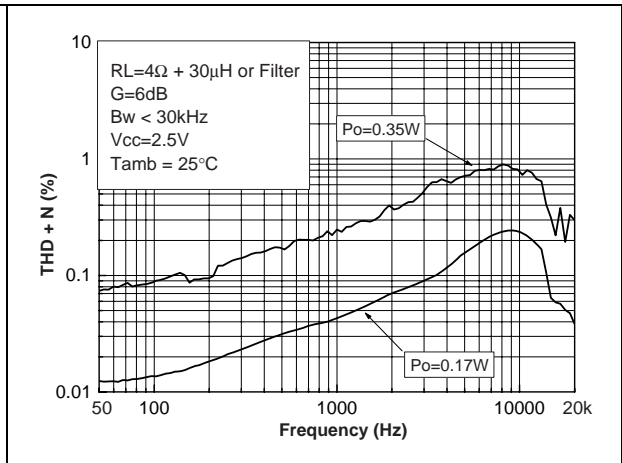

Figure 42. THD+N vs. frequency

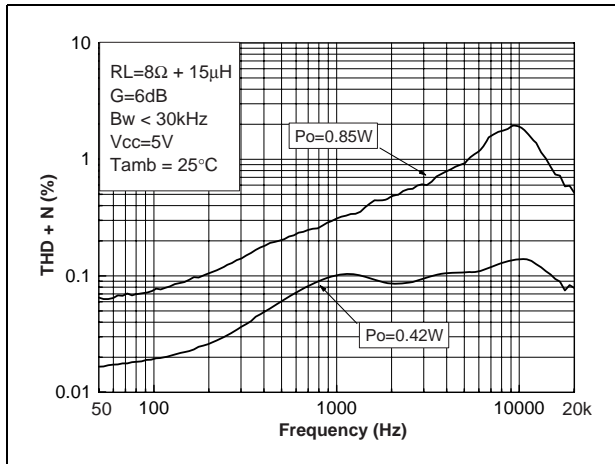

Figure 43. THD+N vs. frequency

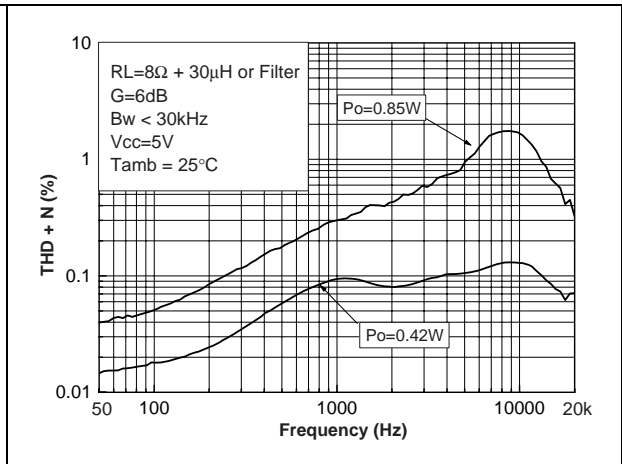

Figure 44. THD+N vs. frequency

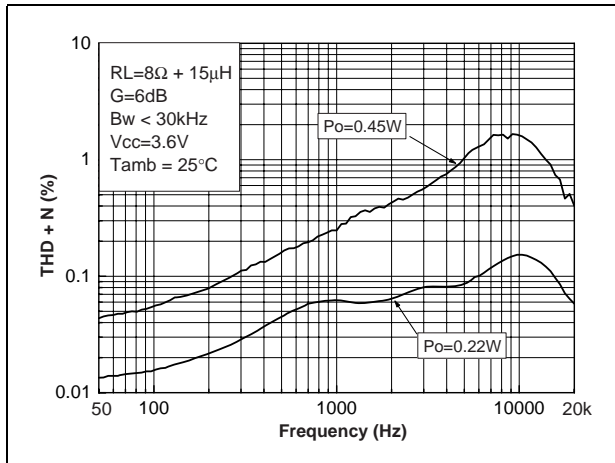

Figure 45. THD+N vs. frequency

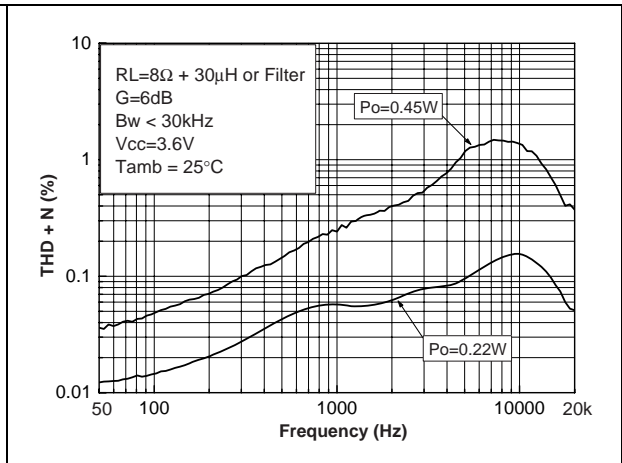

Figure 46. THD+N vs. frequency

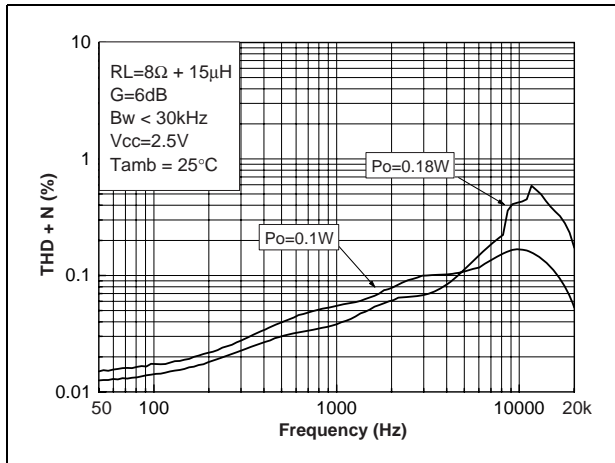

Figure 47. THD+N vs. frequency

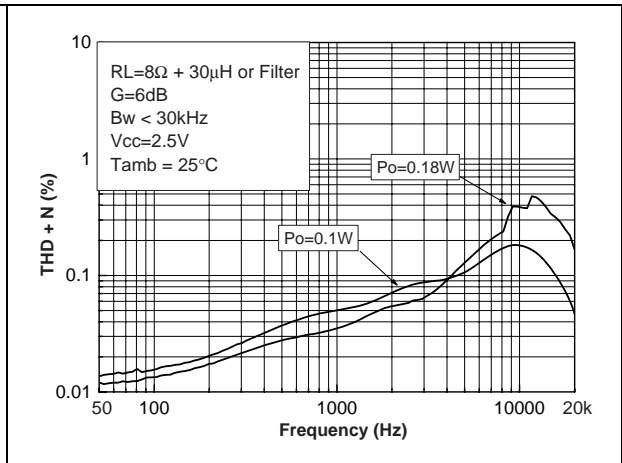

Figure 48. Gain vs. frequency

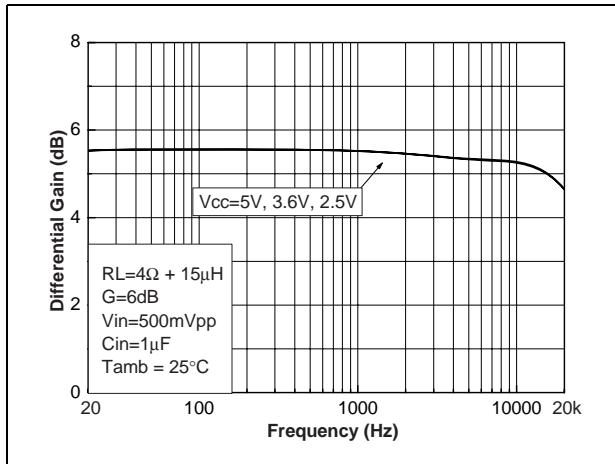

Figure 49. Gain vs. frequency

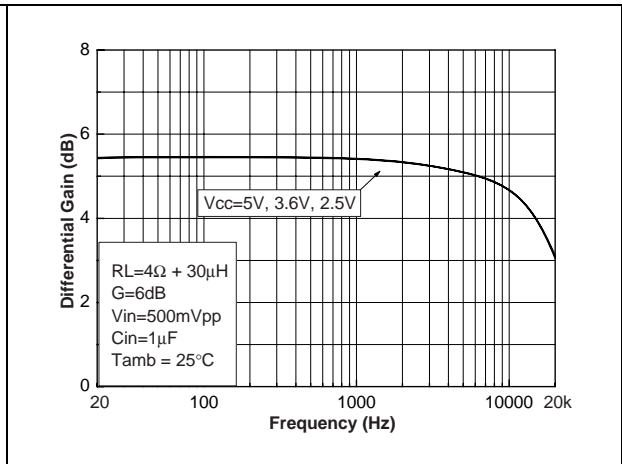

Figure 50. Gain vs. frequency

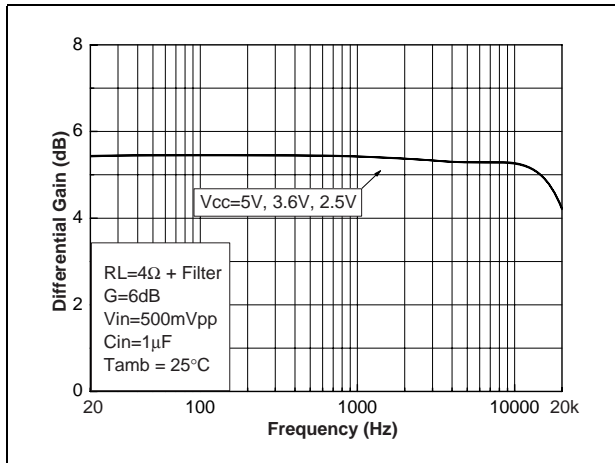

Figure 51. Gain vs. frequency

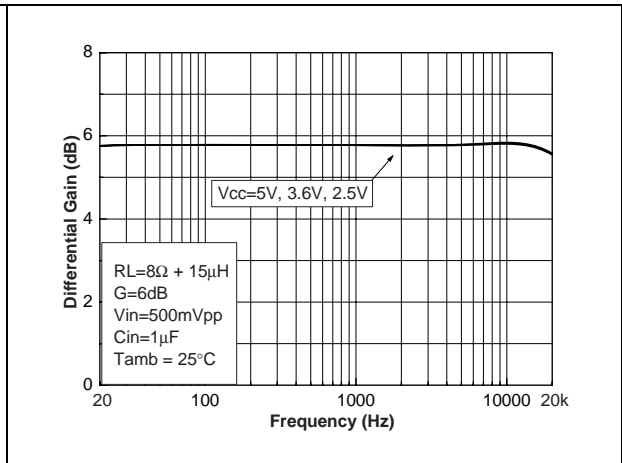

Figure 52. Gain vs. frequency

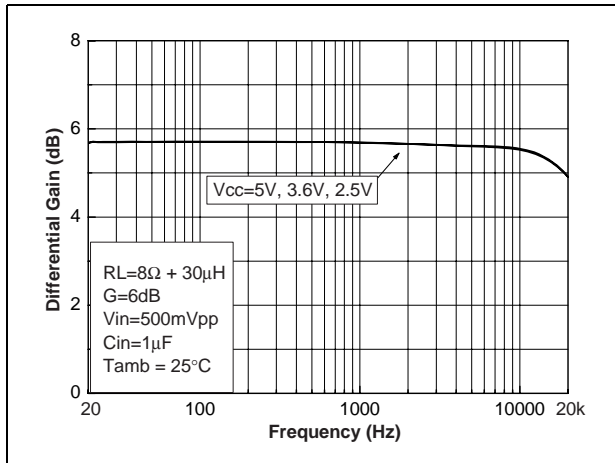

Figure 53. Gain vs. frequency

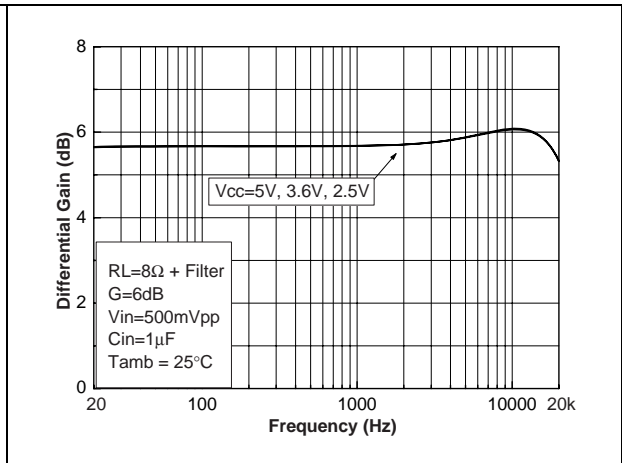

Figure 54. Gain vs. frequency

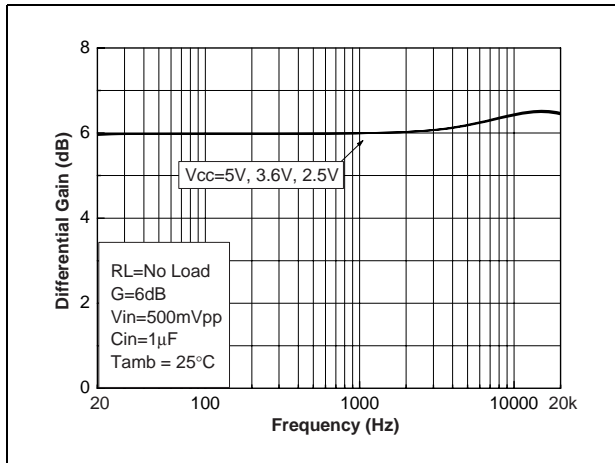

Figure 55. Startup & shutdown time  
V<sub>CC</sub> = 5V, G = 6dB, C<sub>in</sub> = 1μF (5ms/div)

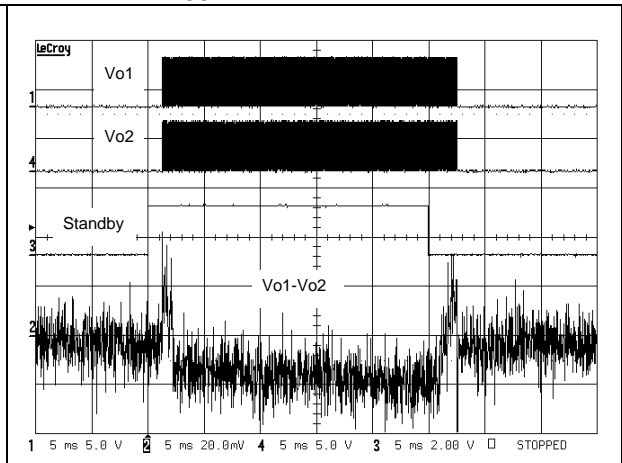

Figure 56. Startup & shutdown time  
V<sub>CC</sub> = 3V, G = 6dB, C<sub>in</sub> = 1μF (5ms/div)

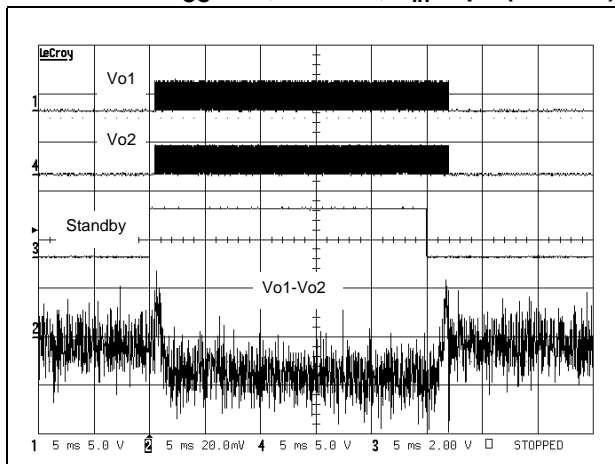

Figure 57. Startup & shutdown time  
V<sub>CC</sub> = 5V, G = 6dB, C<sub>in</sub> = 100nF (5ms/div)

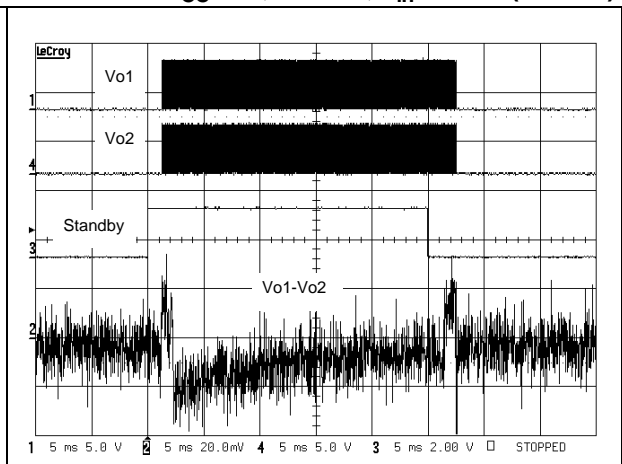

Figure 58. Startup & shutdown time  
 $V_{CC} = 3V, G = 6dB, C_{in} = 100nF$  (5ms/div)

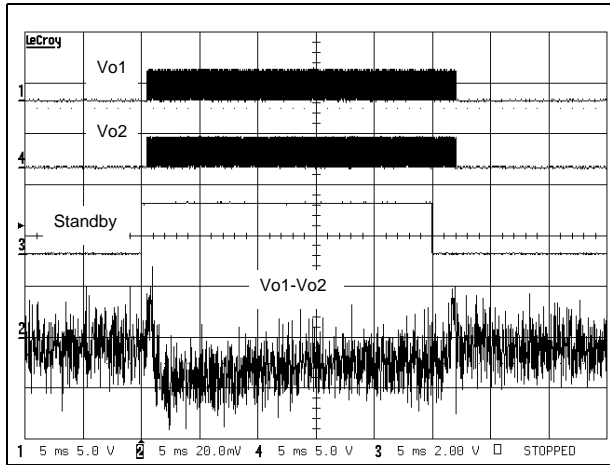

Figure 59. Startup & shutdown time  
 $V_{CC} = 5V, G = 6dB, \text{No } C_{in}$  (5ms/div)

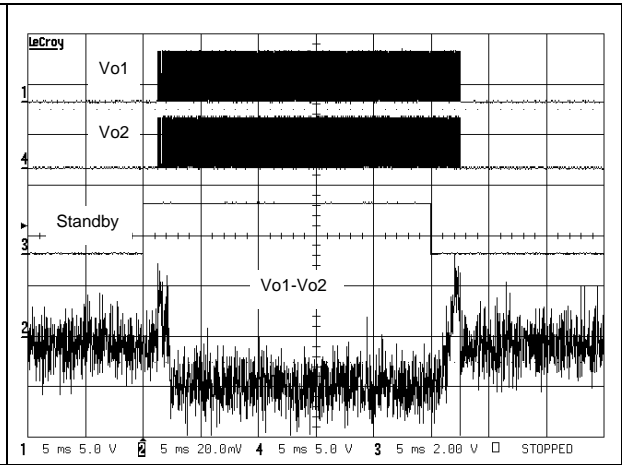
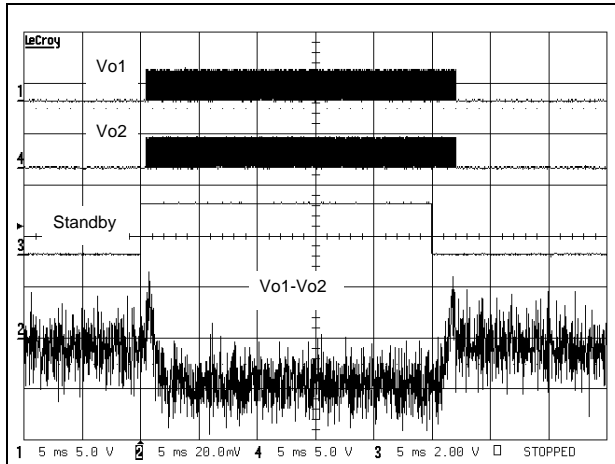

Figure 60. Startup & shutdown time  
 $V_{CC} = 3V, G = 6dB, \text{No } C_{in}$  (5ms/div)



## 4 Application information

### 4.1 Differential configuration principle

The TS4962 is a monolithic fully-differential input/output class D power amplifier. The TS4962 also includes a common-mode feedback loop that controls the output bias value to average it at  $V_{CC}/2$  for any DC common mode input voltage. This allows the device to always have a maximum output voltage swing, and by consequence, maximize the output power. Moreover, as the load is connected differentially compared to a single-ended topology, the output is four times higher for the same power supply voltage.

The advantages of a full-differential amplifier are:

- High PSRR (power supply rejection ratio).
- High common mode noise rejection.
- Virtually zero pop without additional circuitry, giving a faster start-up time compared to conventional single-ended input amplifiers.
- Easier interfacing with differential output audio DAC.
- No input coupling capacitors required because of common mode feedback loop.

The main disadvantage is:

- As the differential function is directly linked to external resistor mismatching, paying particular attention to this mismatching is mandatory in order to obtain the best performance from the amplifier.

### 4.2 Gain in typical application schematic

Typical differential applications are shown in [Figure 1 on page 8](#).

In the flat region of the frequency-response curve (no input coupling capacitor effect), the differential gain is expressed by the relation:

$$A_{V_{diff}} = \frac{Out^+ - Out^-}{In^+ - In^-} = \frac{300}{R_{in}}$$

with  $R_{in}$  expressed in  $k\Omega$

Due to the tolerance of the internal  $150k\Omega$  feedback resistor, the differential gain is in the range (no tolerance on  $R_{in}$ ):

$$\frac{273}{R_{in}} \leq A_{V_{diff}} \leq \frac{327}{R_{in}}$$



### 4.3 Common mode feedback loop limitations

As explained previously, the common mode feedback loop allows the output DC bias voltage to be averaged at  $V_{CC}/2$  for any DC common mode bias input voltage.

However, due to  $V_{icm}$  limitation in the input stage (see [Table 3: Operating conditions on page 7](#)), the common mode feedback loop can play its role only within a defined range. This range depends upon the values of  $V_{CC}$  and  $R_{in}$  ( $A_{Vdiff}$ ). To have a good estimation of the  $V_{icm}$  value, we can apply this formula (no tolerance on  $R_{in}$ ):

$$V_{icm} = \frac{V_{CC} \times R_{in} + 2 \times V_{IC} \times 150k\Omega}{2 \times (R_{in} + 150k\Omega)} \quad (V)$$

with

$$V_{IC} = \frac{In^+ + In^-}{2} \quad (V)$$

and the result of the calculation must be in the range:

$$0.5V \leq V_{icm} \leq V_{CC} - 0.8V$$

Due to the +/-9% tolerance on the 150k $\Omega$  resistor, it's also important to check  $V_{icm}$  in these conditions:

$$\frac{V_{CC} \times R_{in} + 2 \times V_{IC} \times 136.5k\Omega}{2 \times (R_{in} + 136.5k\Omega)} \leq V_{icm} \leq \frac{V_{CC} \times R_{in} + 2 \times V_{IC} \times 163.5k\Omega}{2 \times (R_{in} + 163.5k\Omega)}$$

If the result of  $V_{icm}$  calculation is not in the previous range, input coupling capacitors must be used (with  $V_{CC}$  between 2.4V and 2.5V, input coupling capacitors are mandatory).

#### For example:

With  $V_{CC}=3V$ ,  $R_{in}=150k$  and  $V_{IC}=2.5V$ , we typically find  $V_{icm}=2V$ , which is lower than  $3V-0.8V=2.2V$ . With 136.5k $\Omega$  we find 1.97V and with 163.5k $\Omega$  we have 2.02V. So, no input coupling capacitors are required.

### 4.4 Low frequency response

If a low frequency bandwidth limitation is requested, it is possible to use input coupling capacitors.

In the low frequency region,  $C_{in}$  (input coupling capacitor) starts to have an effect.  $C_{in}$  forms, with  $R_{in}$ , a first order high-pass filter with a -3dB cut-off frequency:

$$F_{CL} = \frac{1}{2\pi \times R_{in} \times C_{in}} \quad (Hz)$$

So, for a desired cut-off frequency we can calculate  $C_{in}$ ,

$$C_{in} = \frac{1}{2\pi \times R_{in} \times F_{CL}} \quad (F)$$

with  $R_{in}$  in  $\Omega$  and  $F_{CL}$  in Hz.

## 4.5 Decoupling of the circuit

A power supply capacitor, referred to as  $C_S$ , is needed to correctly bypass the TS4962.

The TS4962 has a typical switching frequency at 250kHz and output fall and rise time about 5ns. Due to these very fast transients, careful decoupling is mandatory.

A 1 $\mu$ F ceramic capacitor is enough, but it must be located very close to the TS4962 in order to avoid any extra parasitic inductance being created by an overly long track wire. In relation with  $di/dt$ , this parasitic inductance introduces an overvoltage that decreases the global efficiency and, if it is too high, may cause a breakdown of the device.

In addition, even if a ceramic capacitor has an adequate high frequency ESR value, its current capability is also important. A 0603 size is a good compromise, particularly when a 4 $\Omega$  load is used.

Another important parameter is the rated voltage of the capacitor. A 1 $\mu$ F/6.3V capacitor used at 5V loses about 50% of its value. In fact, with a 5V power supply voltage, the decoupling value is about 0.5 $\mu$ F instead of 1 $\mu$ F. As  $C_S$  has particular influence on the THD+N in the medium-high frequency region, this capacitor variation becomes decisive. In addition, less decoupling means higher overshoots, which can be problematic if they reach the power supply AMR value (6V).

## 4.6 Wake-up time ( $t_{WU}$ )

When the standby is released to set the device ON, there is a wait of about 5ms. The TS4962 has an internal digital delay that mutes the outputs and releases them after this time in order to avoid any pop noise.

## 4.7 Shutdown time ( $t_{STBY}$ )

When the standby command is set, the time required to put the two output stages into high impedance and to put the internal circuitry in standby mode is about 5ms. This time is used to decrease the gain and avoid any pop noise during the shutdown phase.

## 4.8 Consumption in standby mode

Between the standby pin and GND there is an internal 300k $\Omega$  resistor. This resistor forces the TS4962 to be in standby mode when the standby input pin is left floating.

However, this resistor also introduces additional power consumption if the standby pin voltage is not 0V.

For example, with a 0.4V standby voltage pin, [Table 3: Operating conditions on page 7](#) shows that you must add  $0.4V/300k\Omega=1.3\mu A$  in typical ( $0.4V/273k\Omega=1.46\mu A$  in maximum) to the standby current specified in [Table 5 on page 9](#).

### 4.9 Single-ended input configuration

It's possible to use the TS4962 in a single-ended input configuration. However, input coupling capacitors are needed in this configuration. The schematics in *Figure 61* show a single-ended input typical application.

**Figure 61. Single-ended input typical application**

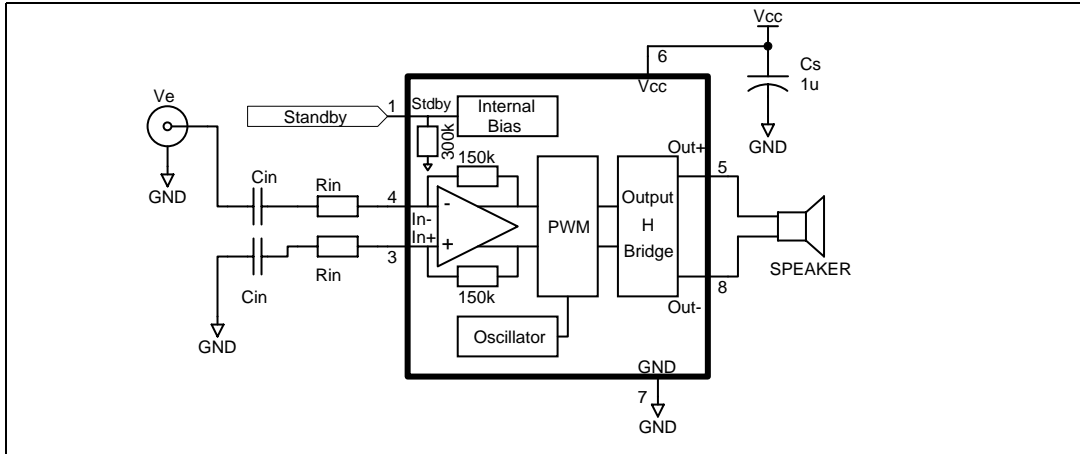

All formulas are identical except for the gain with  $R_{in}$  in  $k\Omega$

$$A_{V\_single} = \frac{V_e}{Out^+ - Out^-} = \frac{300}{R_{in}}$$

And, due to the internal resistor tolerance we have:

$$\frac{273}{R_{in}} \leq A_{V\_single} \leq \frac{327}{R_{in}}$$

In the event that multiple single-ended inputs are summed, it is important that the impedance on both TS4962 inputs ( $In^-$  and  $In^+$ ) are equal.

**Figure 62. Typical application schematic with multiple single-ended inputs**

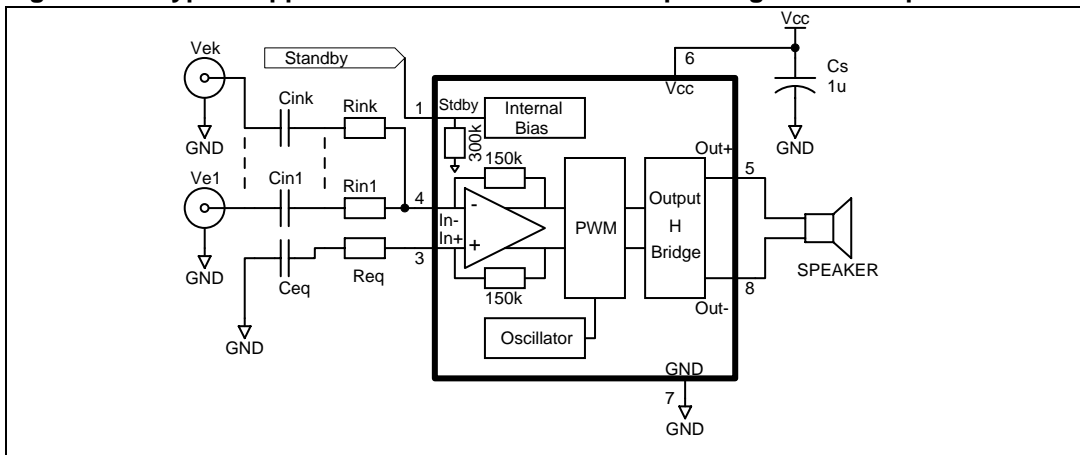

We have the following equations:

$$\text{Out}^+ - \text{Out}^- = V_{e1} \times \frac{300}{R_{in1}} + \dots + V_{ek} \times \frac{300}{R_{ink}} \quad (V)$$

$$C_{eq} = \sum_{j=1}^k C_{ini}$$

$$C_{ini} = \frac{1}{2 \times \pi \times R_{ini} \times F_{CLi}} \quad (F)$$

$$R_{eq} = \frac{1}{\sum_{j=1}^k \frac{1}{R_{ini}}}$$

In general, for mixed situations (single-ended and differential inputs) it is best to use the same rule, that is, to equalize impedance on both TS4962 inputs.

## 4.10 Output filter considerations

The TS4962 is designed to operate without an output filter. However, due to very sharp transients on the TS4962 output, EMI radiated emissions may cause some standard compliance issues.

These EMI standard compliance issues can appear if the distance between the TS4962 outputs and the loudspeaker terminal is long (typically more than 50mm, or 100mm in both directions, to the speaker terminals). As the PCB layout and internal equipment device are different for each configuration, it is difficult to provide a one-size-fits-all solution.

However, to decrease the probability of EMI issues, there are several simple rules to follow:

- Reduce, as much as possible, the distance between the TS4962 output pins and the speaker terminals.
- Use ground planes for “shielding” sensitive wires.
- Place, as close as possible to the TS4962 and in series with each output, a ferrite bead with a rated current at minimum 2.5A and impedance greater than 50Ω at frequencies above 30MHz. If, after testing, these ferrite beads are not necessary, replace them by a short-circuit.
- Allow enough footprint to place, if necessary, a capacitor to short perturbations to ground (see [Figure 63](#)).

**Figure 63. Method for shorting perturbations to ground**

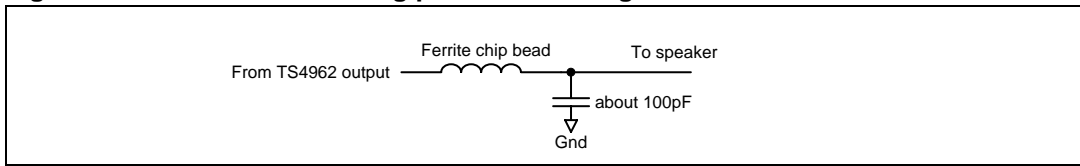

In the case where the distance between the TS4962 output and the speaker terminals is high, it's possible to have low frequency EMI issues due to the fact that the typical operating frequency is 250kHz. In this configuration, we recommend using an output filter (as represented in [Figure 1: Typical application schematics on page 8](#)). It should be placed as close as possible to the device.

## 4.11 Several examples with summed inputs

### Example 1: Dual differential inputs

**Figure 64. Typical application schematic with dual differential inputs**

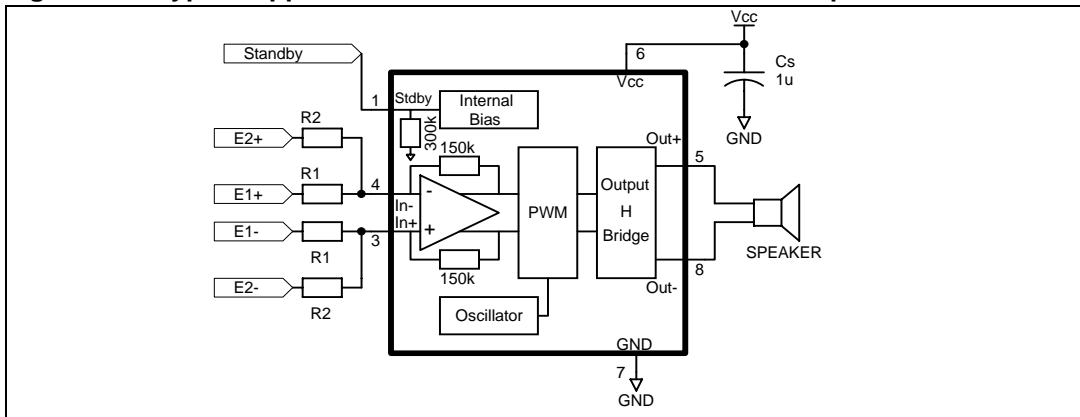

With ( $R_i$  in  $k\Omega$ ):

$$A_{V_1} = \frac{Out^+ - Out^-}{E_1^+ - E_1^-} = \frac{300}{R_1}$$

$$A_{V_2} = \frac{Out^+ - Out^-}{E_2^+ - E_2^-} = \frac{300}{R_2}$$

$$0.5V \leq \frac{V_{CC} \times R_1 \times R_2 + 300 \times (V_{IC1} \times R_2 + V_{IC2} \times R_1)}{300 \times (R_1 + R_2) + 2 \times R_1 \times R_2} \leq V_{CC} - 0.8V$$

$$V_{IC1} = \frac{E_1^+ + E_1^-}{2} \quad \text{and} \quad V_{IC2} = \frac{E_2^+ + E_2^-}{2}$$

**Example 2: One differential input plus one single ended input**

**Figure 65. Typical application schematic with one differential input plus one single-ended input**

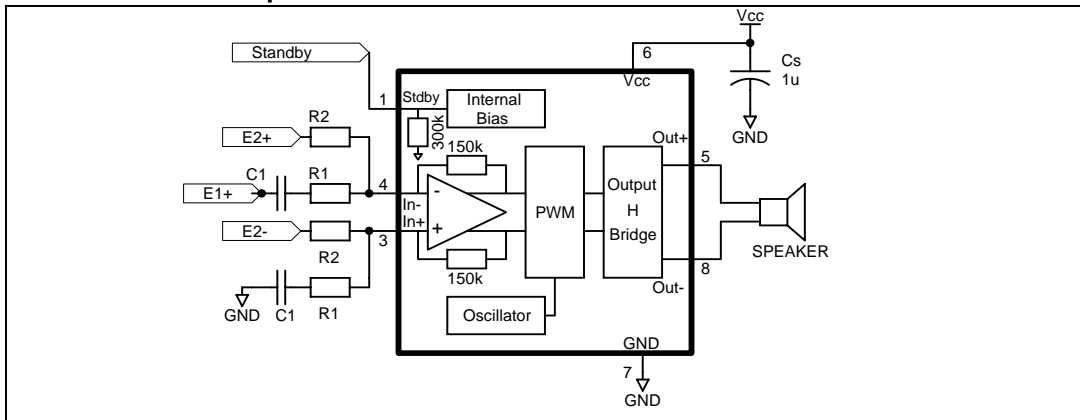

With (R<sub>i</sub> in kΩ) :

$$A_{V_1} = \frac{Out^+ - Out^-}{E_1^+} = \frac{300}{R_1}$$

$$A_{V_2} = \frac{Out^+ - Out^-}{E_2^+ - E_2^-} = \frac{300}{R_2}$$

$$C_1 = \frac{1}{2\pi \times R_1 \times F_{CL}} \quad (F)$$

# 5 Demo board

A demo board for the TS4962 is available. For more information about this demo board, refer to the **Application Note AN2406**.

**Figure 66. Schematic diagram of mono class D demoboard for the TS4962 DFN package**

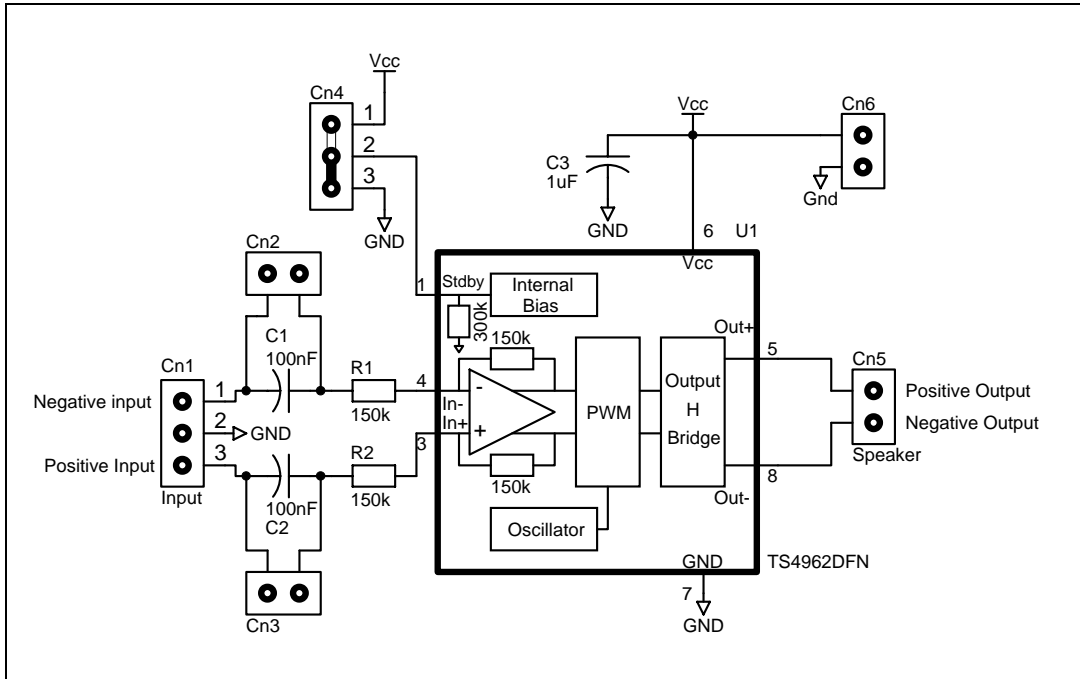

**Figure 67. Top view**

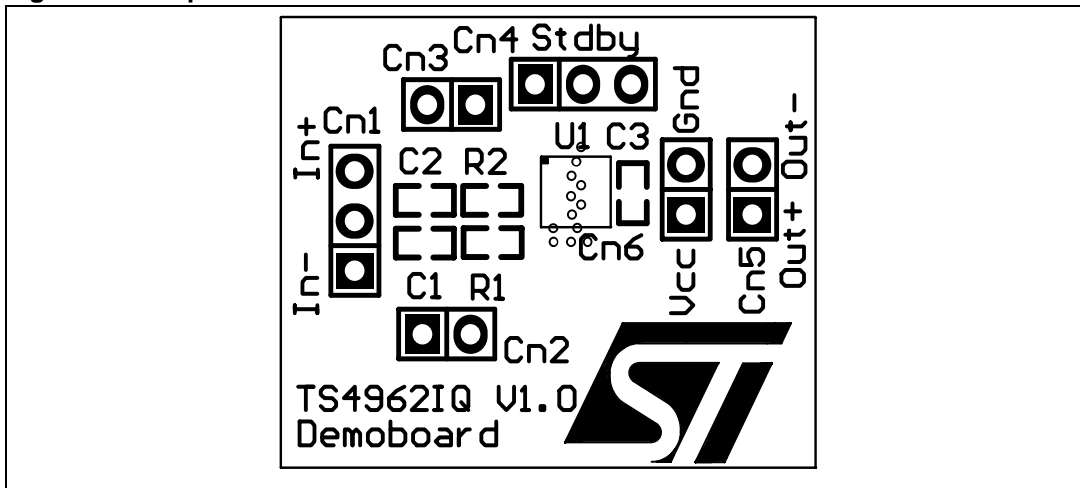

Figure 68. Bottom layer

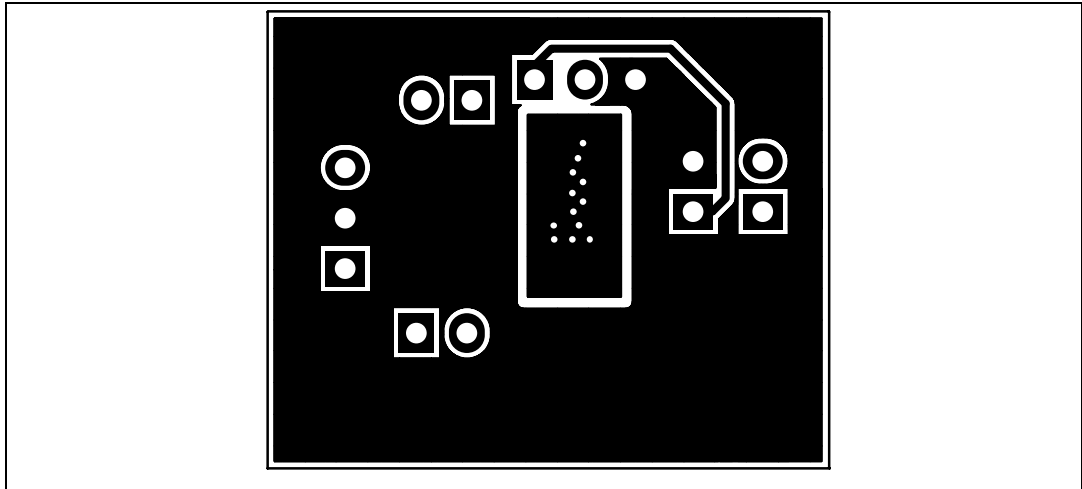
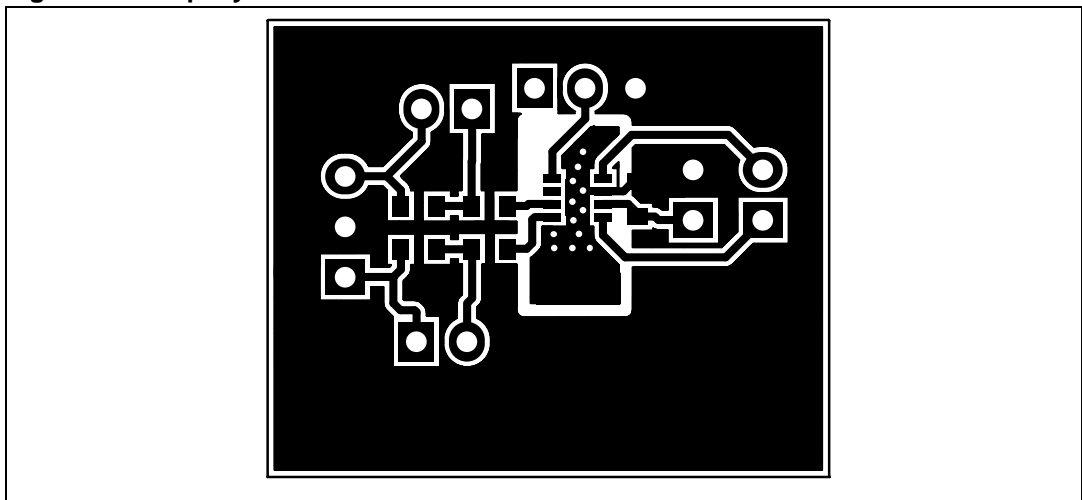

Figure 69. Top layer





## 6 Recommended footprint

Figure 70. Recommended footprint for TS4962 DFN package

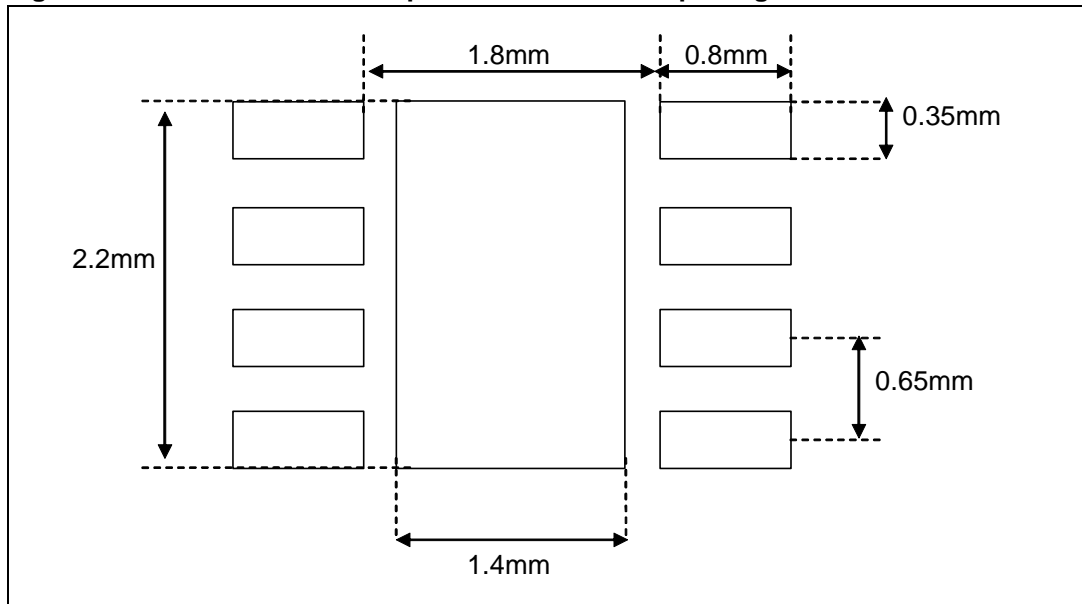

## 7 DFN8 package information

In order to meet environmental requirements, STMicroelectronics offers these devices in ECOPACK<sup>®</sup> packages. These packages have a lead-free second level interconnect. The category of second level interconnect is marked on the package and on the inner box label, in compliance with JEDEC Standard JESD97. The maximum ratings related to soldering conditions are also marked on the inner box label. ECOPACK is an STMicroelectronics trademark. ECOPACK specifications are available at: [www.st.com](http://www.st.com).

Figure 71. DFN8 3x3 exposed pad package

Ref.	Dimensions					
	Millimeters			Mils		
	Min.	Typ.	Max.	Min.	Typ.	Max.
A	0.50	0.60	0.65	19.70	23.62	25.60
A1		0.02	0.05		0.79	1.97
A2		0.40			15.75	
A3		0.15	0.22		5.90	8.67
b	0.25	0.30	0.35	9.85	11.81	13.78
D	2.85	3.00	3.15	112.20	118.10	124.00
D2	1.60	1.70	1.80	63.00	66.93	70.87
E	2.85	3.00	3.15	112.20	118.10	124.00
E2	1.10	1.20	1.30	43.30	47.25	51.18
e		0.65			25.60	
L	0.50	0.55	0.60	19.70	21.65	23.62

Note: DFN8 exposed pad (e2 x d2) is connected to pin number 7.

For enhanced thermal performance, the exposed pad must be soldered to a copper area on the PCB, acting as heatsink. This copper area can be electrically connected to pin7 or left floating.

## 8 Ordering information

Table 11. Order codes

Part number	Temperature range	Package	Packaging	Marking
TS4962IQT	-40° C, +85°C	DFN8	Tape & reel	K962

## 9 Revision history

Table 12. Document revision history

Date	Revision	Changes
31-May-2006	5	Modified package information. Now includes only standard DFN8 package.
16-Oct-2006	6	Added curves in <a href="#">Section 3: Electrical characteristics</a> . Added evaluation board information in <a href="#">Section 5: Demo board</a> . Added recommended footprint.
10-Jan-2007	7	Added paragraph about rated voltage of capacitor in <a href="#">Section 4.5: Decoupling of the circuit</a> .

**Please Read Carefully:**

Information in this document is provided solely in connection with ST products. STMicroelectronics NV and its subsidiaries ("ST") reserve the right to make changes, corrections, modifications or improvements, to this document, and the products and services described herein at any time, without notice.

All ST products are sold pursuant to ST's terms and conditions of sale.

Purchasers are solely responsible for the choice, selection and use of the ST products and services described herein, and ST assumes no liability whatsoever relating to the choice, selection or use of the ST products and services described herein.

No license, express or implied, by estoppel or otherwise, to any intellectual property rights is granted under this document. If any part of this document refers to any third party products or services it shall not be deemed a license grant by ST for the use of such third party products or services, or any intellectual property contained therein or considered as a warranty covering the use in any manner whatsoever of such third party products or services or any intellectual property contained therein.

**UNLESS OTHERWISE SET FORTH IN ST'S TERMS AND CONDITIONS OF SALE ST DISCLAIMS ANY EXPRESS OR IMPLIED WARRANTY WITH RESPECT TO THE USE AND/OR SALE OF ST PRODUCTS INCLUDING WITHOUT LIMITATION IMPLIED WARRANTIES OF MERCHANTABILITY, FITNESS FOR A PARTICULAR PURPOSE (AND THEIR EQUIVALENTS UNDER THE LAWS OF ANY JURISDICTION), OR INFRINGEMENT OF ANY PATENT, COPYRIGHT OR OTHER INTELLECTUAL PROPERTY RIGHT.**

**UNLESS EXPRESSLY APPROVED IN WRITING BY AN AUTHORIZED ST REPRESENTATIVE, ST PRODUCTS ARE NOT RECOMMENDED, AUTHORIZED OR WARRANTED FOR USE IN MILITARY, AIR CRAFT, SPACE, LIFE SAVING, OR LIFE SUSTAINING APPLICATIONS, NOR IN PRODUCTS OR SYSTEMS WHERE FAILURE OR MALFUNCTION MAY RESULT IN PERSONAL INJURY, DEATH, OR SEVERE PROPERTY OR ENVIRONMENTAL DAMAGE. ST PRODUCTS WHICH ARE NOT SPECIFIED AS "AUTOMOTIVE GRADE" MAY ONLY BE USED IN AUTOMOTIVE APPLICATIONS AT USER'S OWN RISK.**

Resale of ST products with provisions different from the statements and/or technical features set forth in this document shall immediately void any warranty granted by ST for the ST product or service described herein and shall not create or extend in any manner whatsoever, any liability of ST.

ST and the ST logo are trademarks or registered trademarks of ST in various countries.

Information in this document supersedes and replaces all information previously supplied.

The ST logo is a registered trademark of STMicroelectronics. All other names are the property of their respective owners.

© 2007 STMicroelectronics - All rights reserved

STMicroelectronics group of companies

Australia - Belgium - Brazil - Canada - China - Czech Republic - Finland - France - Germany - Hong Kong - India - Israel - Italy - Japan - Malaysia - Malta - Morocco - Singapore - Spain - Sweden - Switzerland - United Kingdom - United States of America

[www.st.com](http://www.st.com)